

Final Report

B777-300ER, 9V-SWM Turbulence Event over Myanmar

21 MAY 2024

TIB/AAI/CAS.231

Transport Safety Investigation Bureau
Ministry of Transport
Singapore

18 May 2026

The Transport Safety Investigation Bureau of Singapore

The Transport Safety Investigation Bureau of Singapore (TSIB) is the air, marine and rail accidents and incidents investigation authority in Singapore. Its mission is to promote transport safety through the conduct of independent investigations into air, marine and rail accidents and incidents.

The TSIB conducts air safety investigations in accordance with the Singapore Transport Safety Investigations Act 2018, Transport Safety Investigations (Aviation Occurrences) Regulations 2023 and Annex 13 to the Convention on International Civil Aviation, which governs how member States of the International Civil Aviation Organization (ICAO) conduct aircraft accident investigations internationally.

The sole objective of TSIB's air safety investigations is the prevention of aviation accidents and incidents. The safety investigations do not seek to apportion blame or liability. Accordingly, TSIB reports should not be used to assign blame or determine liability.

Table of Contents

ABBREVIATIONS	v
SYNOPSIS	1
1 Factual information	2
1.1 History of the flight	2
1.2 Injuries to persons	10
1.3 Damage to aircraft	10
1.4 Personnel information	12
1.5 Aircraft information	14
1.6 Meteorological information	19
1.7 Flight recorders	25
1.8 Medical information	27
1.9 Survival aspects	27
1.10 Additional information	27
2 Analysis	35
2.1 The turbulence event	35
2.2 Flight crew's visual observation of environmental conditions	36
2.3 Possibility of no-painting of occurrence aircraft WXR	37
2.4 Issue of under-painting of the occurrence aircraft WXR	38
2.5 WXR system tests at OEM facility	38
2.6 Troubleshooting WXR defects using the maintenance manual	40
2.7 Performance of aircraft WXR	41
2.8 Weather information recordings	41

2.9	Fastening of seat belt	42
3	Conclusions	43
4	Safety actions	45
5	Safety recommendations	47
	Appendix	48

ABBREVIATIONS

ACARS	Aircraft Communications Addressing and Reporting System
AGP	Augmenting Pilot
AMM	Aircraft Maintenance Manual
ATC	Air Traffic Control
ATP	Acceptance Test Procedure
CAL	Calibrate
CAT	Clear Air Turbulence
CB	Cumulonimbus
CIT	Convectively Induced Turbulence
CP	Control Panel
CVR	Cockpit Voice Recorder
DA	Antenna Drive Unit
DFDR	Digital Flight Data Recorder
EICAS	Engine Indications and Crew Alerting System
eWAS	Electronic Weather Awareness System
FAA	U. S. Federal Aviation Administration
FCMIR	Flight crew-machine interface recording
FCTM	Flight [△] Crew Training Manual
FIR	Flight Information Region
FL	Flight Level
ft	Feet
ft/min	Feet Per Minute

[△] “Fight” amended to “Flight”.

ft/sec	Feet Per Second
G	Gravitational Force
ICAO	International Civil Aviation Organization
IFM	In-Flight Manager
MAX	Maximum
MIN	Minimum
mm/hr	Millimetre Per Hour
m/s	Metre Per Second
MSL	Mean Sea Level
MSS	Meteorological Service Singapore
ND	Navigation Display
nm	Nautical Mile
NTSB	United States National Transportation Safety Board
OEM	Original Equipment Manufacturer
PIC	Pilot-in-Command
PF	Pilot Flying
PFD	Primary Flight Display
PM	Pilot Monitoring
PSU	Passenger Service Unit
RDCA	Rapidly Developing Cumulus Area
RP	Radar Processor
SFO	Senior First Officer
TCU	Towering Cumulus Clouds

TR	Transceiver
TSIB	Transport Safety Investigation Bureau of Singapore
VAR	Variable
WXR	Weather Radar

SYNOPSIS

On 20 May 2024, a Boeing B777 departed London for Singapore. While flying over Southwest Myanmar on 21 May 2024, it encountered severe turbulence. The aircraft diverted to Suvarnabhumi Airport in Bangkok, Thailand. 56 persons^Δ were found seriously injured, 23 minorly injured and one passed away¹.

The Myanmar Transport Safety Branch delegated the investigation of this occurrence to the Transport Safety Investigation Bureau of Singapore (TSIB). The TSIB classified this occurrence as an accident.

AIRCRAFT DETAILS

Boeing B777-300ER	
Operator	: Singapore Airlines
Aircraft registration	: 9V-SWM
Date and time of incident	: 21 May 2024 at 0749 hrs UTC
Location of occurrence	: Southwest Myanmar
Type of flight	: Scheduled
Persons on board	: 229

¹ The cause of death stated heart failure and lung edema.

^Δ “56 passengers” has been amended to “56 persons”.

1 **FACTUAL INFORMATION**

All times used in this report are in Coordinated Universal Time (UTC).

1.1 History of the flight

1.1.1 At about 21:38 on 20 May 2024, a Boeing B777-300ER departed Heathrow Airport, London, for Singapore. The flight crew comprised a Pilot-in-Command (PIC), a Captain, a Senior First Officer (SFO) and an Augmenting Pilot (AGP), also a Captain.

1.1.2 Prior to departure, while at the gate in Heathrow Airport, the PIC conducted a pre-flight briefing to the In-Flight Manager (IFM). The IFM understood from the briefing that there would be weather as the aircraft got closer to Singapore².

1.1.3 During the departure and climb from Heathrow Airport and during cruise until reaching the Yangon Flight Information Region (FIR), the flight was smooth. The aircraft weather radar (WXR), according to the flight crew, appeared to operate normally. The flight crew observed no weather of concern on the flight path. The flight crew did not need to carry out any deviation or circumnavigation.

1.1.4 At about 07:30 on 21 May 2024, the aircraft was approaching the southwestern region of Myanmar (for easy referencing in this report, the southwestern region of Myanmar in which the aircraft was flying is hereinafter referred to as Southwest Myanmar, see **Figure 1**). The PIC was seated on the left, the AGP on the right, and the SFO resting in the crew rest facility behind the cockpit. The PIC was the Pilot Flying (PF) and the AGP, the Pilot Monitoring (PM). The aircraft was being operated under Instrument Flight Rules³ (IFR) and according to the flight crew, they were in Visual Meteorological Conditions⁴ (VMC).

² It is usual for the region around Singapore and Myanmar, being close to the equator, to have convective clouds develop daily and it is normal for aircraft departing from Singapore or flying to Singapore to traverse such weather.

³ IFR refers to a set of aviation regulations and procedures where pilots navigate by reference to the flight instruments, rather than by outside visual references.

⁴ VMC refers to weather conditions that allow pilots to fly using visual references, meaning that the pilots can see terrain, other aircraft, etc.



(Source: Myanmar AIP) (Annotation: TSIB)

Figure 1: Southwest Myanmar within the Yangon Flight Information Region (FIR)

1.1.5 The aircraft was cruising at Flight Level (FL) 370 (i.e. 37,000ft) when it was approaching the west coast of Southwest Myanmar. In the cabin, passengers were being wakened from resting or sleeping while cabin crew were preparing for breakfast service. According to the flight crew, at about 15 minutes prior to overflying waypoint PTN in Southwest Myanmar, there were no weather radar returns (hereinafter referred to as weather returns) displayed on the flight

crew's navigation displays⁵ (NDs). (For easy referencing in this report, the location at about 15 minutes prior to overflying PTN is hereinafter referred to as Location Z (see **Figure 2**). Location Z is about 135nm from waypoint PTN.)

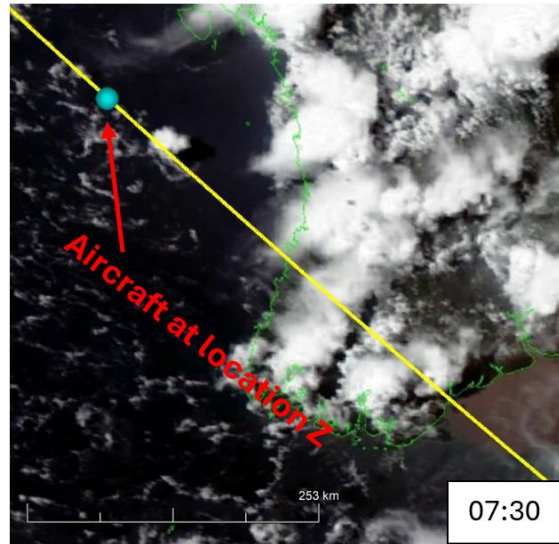

(Source: MSS) (Annotation: TSIB)

Figure 2: Location Z – location of aircraft about 15mins to PTN

- 1.1.6 At this time, both NDs were set at a range of 320nm. The flight crew looked outside the cockpit window. The AGP noted that the immediate flight path⁶ was clear of cloud. The PIC said that he saw cirrus clouds⁷ (high level clouds) in the distance but the immediate flight path ahead was clear. According to the flight crew, after looking outside the cockpit window, they continued to monitor the flight instruments (see paragraph 1.5.4). The recording in the cockpit voice recorder (CVR) does not contain any discussion in the cockpit regarding clouds over the Myanmar land mass.
- 1.1.7 The aircraft has two selectable weather radar (WXR) systems, Left and Right (WXR-L and WXR-R), to provide weather information to the flight crew on the NDs⁸. Only one WXR system, as selected by the flight crew, operates at any

⁵ There are two NDs, one in front of each pilot's seating position.

⁶ The AGP stated they were flying in clear weather and there was no cloud ahead as far as the AGP could see. The AGP did not see any clouds below the aircraft.

⁷ Cirrus clouds are high level clouds typically found between 20,000ft and 60,000ft. They are composed of ice crystals and often appear as thin, white or translucent clouds. They are not associated with convective activity. They are usually not detected by weather radar. They have similar visual traits as fog or haze and may restrict forward visibility. *Source: World Meteorological Organization.*

⁸ See paragraph 1.5.2 for information on WXR systems.

one time. On this flight, WXR-R was used⁹. On the WXR control panel (CP)¹⁰, the Mode for WXR operation and GAIN knob set by the PIC and AGP were as shown below. According to the PIC and AGP, WXR-R appeared to be operating normally and there were no faults or failure flags for WXR-R.

PIC (left-seated pilot)	AGP (right-seated pilot)
Mode for WXR operation set to MAN ¹¹ (with Altitude knob set to 33,000ft) GAIN ¹² knob set to MAX	Mode for WXR operation set to AUTO (not necessary to set the Altitude knob) GAIN knob set to CAL

1.1.8 At 07:44:52, the aircraft was approaching waypoint PTN while on its way to waypoint POXEM. The flight crew contacted Yangon air traffic control (ATC) to request for a direct route to waypoint EKAVO due to weather¹³. Yangon ATC counter-offered a direct route to waypoint DWI. The flight crew accepted this route (see **Figure 3**).

⁹ When both WXR-R and WXR-L are serviceable, the operator's policy is for the flight crew to use WXR-L on flights outbound from Singapore and WXR-R on the flights inbound to Singapore.

¹⁰ See **Figure 11** in paragraph 1.5.2.4 for a picture of the CP.

¹¹ WXR system can operate in either map (MAP), automatic (AUTO) or manual (MAN) mode.

¹² Gain refers to WXR's sensitivity setting between MAX (Maximum) and MIN (Minimum) with a CAL (Calibrated) position in the middle. Adjusting the GAIN knob allows WXR to increase or decrease the intensity of weather returns displayed (more on gain control in paragraph 1.5.2.5).

¹³ According to the flight crew, there was no concern regarding the weather. However, weather was cited by them to increase the likelihood of ATC approving their request for the direct route.



(Source: operator) (Annotation: TSIB)

Figure 3: Flight route and deviation

- 1.1.9 At 07:45:15, the PIC and AGP adjusted the range of their NDs from 320nm to 640nm to bring waypoint EKAVO into view for flight path planning.
- 1.1.10 At 07:45:19, the PIC changed the left ND range back to 320nm.
- 1.1.11 At 07:45:55, the AGP changed the right ND range back to 320nm. Thereafter, the AGP adjusted the ND range from 320nm to 160nm and eventually to 40nm. According to the AGP, there were no weather returns and the range adjustments to the ND was part of routine cockpit actions. During this period of ND range adjustments by the AGP, there was no recording in the CVR pertaining to any discussion on weather between the PIC and AGP.
- 1.1.12 At 07:49:23, the aircraft was cruising over Southwest Myanmar at FL370 at a speed of 0.84 Mach, the aircraft experienced an onset of turbulence. The digital flight data recorder (DFDR) data showed that the aircraft experienced vertical

accelerations in the range from +0.44G to +1.57G¹⁴ over the next 17 seconds. At about the same time, the AGP noticed that the airspeed was increasing towards the overspeed range and alerted the PIC. The AGP deployed the speed brakes to prevent an overspeed situation.

- 1.1.13 Subsequently, according to the PIC, he adjusted the cruising speed from 0.84 Mach to the turbulence penetration speed of 0.82 Mach¹⁵ via speed selector knob and switched on the fasten-seat-belt sign. He also called out “Seat belt on”¹⁶.
- 1.1.14 The aircraft altimeter registered an increase in altitude and the autopilot system responded by progressively pitching the aircraft nose-down to descend the aircraft to the set altitude of 37,000ft. However, the altitude continued to increase and reached 37,362ft.
- 1.1.15 At 07:49:40, when the aircraft had flown about 30nm past waypoint PTN, the aircraft experienced what the flight crew later reported to Yangon ATC as severe turbulence (see paragraph 1.1.18). The DFDR data showed that vertical acceleration decreased from +1.35G to -1.5G¹⁷ (i.e. a change of 2.85G) within 0.6 seconds and then increased from -1.5G to +1.5G¹⁸ (i.e. a change of 3G) within the next 4 seconds. The stick shaker (a stall warning system) was momentarily activated. The DFDR data showed that the flight crew had initiated manual control inputs to stabilise the aircraft, disengaging the autopilot in this process. The pilots manually controlled the aircraft for 21 seconds and reengaged the autopilot at 07:50:05. At 07:50:48, the AGP adjusted the right ND range back to 320nm.
- 1.1.16 At about 07:51, after the turbulence event, the flight crew noticed that the area outside the aircraft was clear. According to the CVR recording, the PIC said “How come suddenly¹⁹...let me remove this²⁰ and see”, but there was no further discussion on what he saw. At 07:53:00, the CVR recorded the PIC saying “we hit something but I was on MAX ... I was on MAX²¹ I don’t see anything here”.

¹⁴ Gravitational force (G) is a measure of acceleration that compares the force experienced by the aircraft with the force corresponding to the acceleration due to gravity.

¹⁵ This is the speed required in the Flight Crew Operating Manual (FCOM) for flying through turbulence to avoid exceeding structural design limits.

¹⁶ This call-out was captured in the recording of the CVR. The flight crew did not have time to make a public announcement (PA).

¹⁷ This magnitude of change could cause an occupant who is not belted up to become airborne.

¹⁸ During a change from negative G to positive G, an occupant who has been airborne will fall back down.

¹⁹ The PIC was referring to being surprised by the sudden onset of turbulence.

²⁰ The PIC was referring to retracting the sunshade at his side window.

²¹ The PIC had his GAIN knob set at MAX (paragraph 1.1.7).

At 07:53:38, after the aircraft stabilised and the turbulence had subsided, the CVR recorded the AGP saying “OK we are clear²² already ... the weather is OK” and the PIC saying, “Quite clear now”.

- 1.1.17 According to the PIC, he looked outside the aircraft but did not see any cloud in the vicinity after the turbulence event and both NDs did not display any weather returns. The AGP also looked outside and did not see any cloud.
- 1.1.18 Shortly after, the flight crew were informed by the cabin crew of multiple injuries in the cabin. At about 07:55, the flight crew reported to Yangon ATC that they had encountered severe turbulence and enquired if there had been any turbulence reports from other aircraft in the vicinity at FL370. Yangon ATC replied that they had not received any turbulence reports from other aircraft in the vicinity.
- 1.1.19 The SFO, who had been resting in the crew rest facility, was awoken by the turbulence and he went back to the cockpit. On his way to the cockpit, the SFO saw toppled service carts and broken service wares. The SFO also saw an injured cabin crew member being attended to by the IFM. He reported to the PIC what he saw. The CVR recorded the SFO saying to the cabin crew at 07:53:49 “OK weather at the moment in front looks clear²³ ...”
- 1.1.20 At about 08:01, the flight crew declared Mayday to Yangon ATC and requested for a diversion to Suvarnabhumi Airport, Bangkok, Thailand. Yangon ATC coordinated the diversion with Bangkok ATC.
- 1.1.21 At about 08:03, the flight crew sent an ACARS²⁴ message to inform the operator that the aircraft would be diverting to Bangkok in view of the injuries sustained during the turbulence event.
- 1.1.22 At about 08:06, the PIC directed the SFO to take over from the AGP as PM. The AGP remained in the flight deck to assist in monitoring the flight and coordinating with the cabin crew from the observer seat.
- 1.1.23 At about the same time, Yangon ATC instructed the aircraft to descend from FL370 to FL310. During the descent to FL310 and thereafter while maintaining at FL310, the PIC saw altostratus²⁵ and scattered cumulus clouds ahead of the

²² The AGP’s mention of “clear” was with reference to the bumpiness of the flight, i.e. the subsiding of turbulence.

²³ The SFO was communicating with the cabin crew on the cabin interphone in response to the cabin crew’s enquiry as to whether it was safe to move around.

²⁴ Aircraft Communications Addressing and Reporting System (ACARS).

²⁵ Altostratus are a greyish or bluish cloud sheet or layer of striated, fibrous or uniform appearance, totally or partly covering the sky. *Source: World Meteorological Organization.*

aircraft. According to the flight crew, there were still no weather returns displayed on their NDs.

- 1.1.24 At about 08:07, the AGP went to the cabin to assess the situation. The AGP returned shortly with the IFM and reported that one passenger was unconscious, and that cardiopulmonary resuscitation was being administered to the unconscious passenger²⁶. The IFM reported that there were enough cabin crew members to man all the cabin doors for landing.
- 1.1.25 The AGP then left the cockpit again with the IFM to continue assessing the cabin situation. The AGP returned about two minutes later to monitor the flight and to assist the PIC and SFO in the preparation for the diversion to Bangkok.
- 1.1.26 At about 08:09, Yangon ATC instructed the flight crew to contact Bangkok ATC. Bangkok ATC directed the flight crew to descend to FL170. Before descending below FL310, the PIC changed his WXR Mode setting from MAN to AUTO and the GAIN knob setting from MAX to CAL. The flight crew recalled that it was only while descending below FL310 that they saw weather returns on their NDs. Around this time, the CVR recorded the flight crew discussing about clouds around them.
- 1.1.27 The PIC instructed the cabin crew to prepare the cabin for landing. Cabin crew members who were not seriously injured or uninjured tended to the injured persons with the help of some passengers. Some of the injured passengers were helped back to their seats and had their seat belts fastened. Injured cabin crew members and passengers²⁷ who could not be moved back to their seats were cushioned with pillows and blankets where they were and were secured by being held down by those who were seated adjacent to them during the approach to land. The IFM ensured all cabin doors were manned by cabin crew members who were still able to carry out their safety duties.
- 1.1.28 At about 08:45, the aircraft landed at Suvarnabhumi Airport. At about 08:50, the aircraft arrived at its assigned parking bay. The aircraft was met by medical personnel at the parking bay and the injured were treated and sent to hospitals.

²⁶ This passenger was found unconscious and moved from his seat to door 3 left where the CPR was commenced.

²⁷ Some injured cabin crew members and passengers (in particular, those with potential back injuries) were not moved as a precaution so as not to aggravate their injuries.

1.2 Injuries to persons

Injuries	Flight Crew	Cabin Crew	Passengers	Total
Fatal	0	0	1	1
Serious	0	5	51	56
Minor	0	1	22	23
Uninjured	3	9	137	149
Total	3	15	211	229

1.2.1 The injuries were mostly to the head, neck and spine in the form of fractures, compressions, lacerations, and dislocations.

1.2.2 According to the Air Accident Investigation Commission (AAIC) of Thailand, an autopsy of the deceased²⁸ was performed by the Thai Police and the official certificate from the Thai Police stated that the cause of death was heart failure and lung edema²⁹.

1.3 Damage to aircraft

1.3.1 The damage in the cabin interior included broken ceiling panels, dislodged overhead passenger service units (PSUs³⁰), punctured overhead bins, damaged seat backrest reclining mechanism, cracked sidewall panels and broken sidewall lights (see **Figure 4** to **Figure 9**).

²⁸ The deceased person is the unconscious passenger mentioned in paragraph 1.1.24.

²⁹ A condition due to too much fluid in the lungs, resulting in difficulty in breathing.

³⁰ A PSU is a cabin service panel that provides cabin occupants with reading lights, blower air outlet, fasten seat belt sign, attendant call lights and deploys stowed oxygen masks during a cabin depressurisation emergency.



Figure 4: Broken ceiling panel

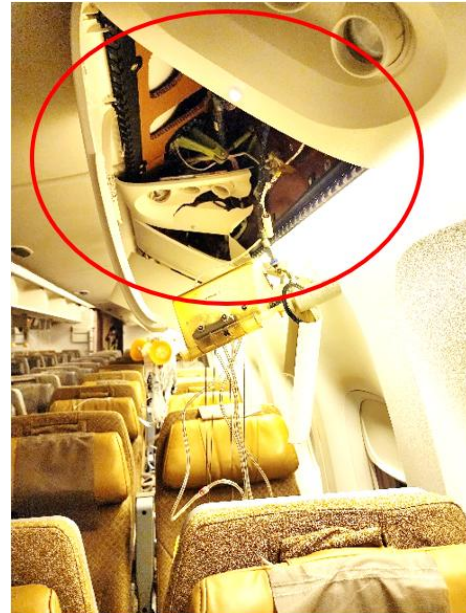

Figure 5: Broken PSUs with oxygen masks dislodged



Figure 6: Punctured overhead bin

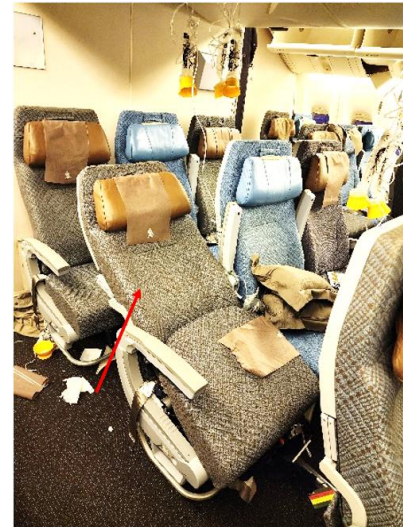

Figure 7: Damaged seat backrest reclining mechanism



Figure 8: Cracked sidewall panel



Figure 9: Broken sidewall light

1.4 Personnel information

1.4.1 PIC (Pilot in Command)

Age	60
Licence type	Air Transport Pilot Licence (ATPL)
Issuing authority	Civil Aviation Authority of Singapore
Licence validity	Valid till 31 March 2025
Medical certificate	Class one
Medical certificate validity	Valid till 30 November 2024
Medical operational proviso	Holder shall wear corrective lenses that correct for both distant and near vision and have available a second pair of spectacles whilst exercising the privileges of the licence.
Last Proficiency Check date	1 April 2024
Last Line Check date	29 November 2023
Total flying hours	21,922hr 54min
Aircraft types flown	Airbus A343, A359, A388, Boeing B743, B744, B777

Total hours on type	6,816hr 12min
Flying in last 90 days	248hr 4min
Flying in last 7 days	25hr 52min
Flying in last 24 hours	0
Duty time in last 48 hours	3hr 15min ³¹
Rest period in last 48 hours	44hr 45min

1.4.2 AGP (Augmenting Pilot)

Age	51
Licence type	Air Transport Pilot Licence (ATPL)
Issuing authority	Civil Aviation Authority of Singapore
Licence validity	Valid till 19 March 2025
Medical certificate	Class one
Medical certificate validity	Valid till 30 April 2025
Medical operational proviso	Holder shall wear corrective lenses that correct for both distant and near vision and have available a second pair of spectacles whilst exercising the privileges of the licence.
Last Proficiency Check date	20 March 2024
Last Line Check date	14 November 2023
Total flying hours	13,791hr 12min
Aircraft types flown	Airbus A320, Boeing B737, B777
Total hours on type	1,226hr 10min
Flying in last 90 days	238hr 25min
Flying in last 7 days	24hr 50min
Flying in last 24 hours	0
Duty time in last 48 hours	3hr 15min
Rest period in last 48 hours	44hr 45min

1.4.3 SFO (Senior First Officer)

Age	40
Licence type	Air Transport Pilot Licence (ATPL)
Issuing authority	Civil Aviation Authority of Singapore
Licence validity	Valid till 31 July 2024

³¹ 3hrs 15min of standby duty for all three flight crew.

Medical certificate	Class one
Medical certificate validity	Valid till 31 July 2024
Medical operational proviso	Nil
Last Proficiency Check date	27 December 2023
Last Line Check date	23 February 2024
Total flying hours	6,230hr
Aircraft types flown	Airbus A320, Boeing B737, B777
Total hours on type	1,146hr
Flying in last 90 days	248hr 48min
Flying in last 7 days	14hr 18min
Flying in last 24 hours	0
Duty time in last 48 hours	3hr 15min
Rest period in last 48 hours	44hr 45min

1.5 Aircraft information

1.5.1 Fasten-seat-belt sign

1.5.1.1 A post-occurrence test of the fasten-seat-belt sign system in Bangkok showed that the system was working normally.

1.5.2 Weather radar (WXR) system

1.5.2.1 The aircraft is fitted with two selectable WXR systems, WXR-L and WXR-R, which use the same WXR antenna. When a WXR system is selected, weather returns from that WXR system will be displayed on the left and right NDs.

1.5.2.2 According to the WXR original equipment manufacturer (OEM), the WXR can detect rainfall above an intensity of 0.7mm/hr up to 320nm in front of the aircraft and 80 degrees left and right³² (see **Figure 10**).

³² The WXR detects rainfall in convective clouds. It does not detect such clouds as cirrus clouds and stratus clouds, which consist mainly of ice crystals and no rainfall.

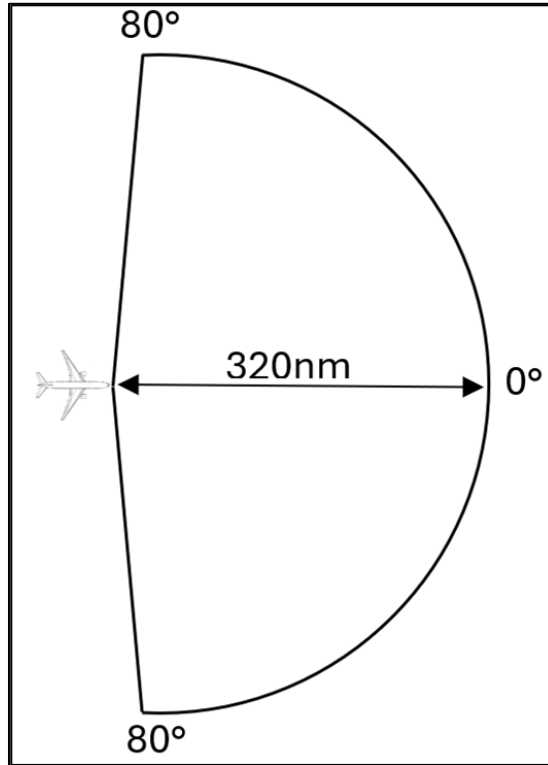

(Not to scale)

Figure 10: Rainfall detection range and azimuth of WXR

1.5.2.3 Weather information is categorised as primary or secondary. Primary weather is the weather detected within the aircraft flight path envelope³³ and secondary weather is the weather detected outside the aircraft flight path envelope (except when a WXR capability known as the Convective Weather Discrimination is in effect. See Footnote 34 in 1.5.2.6(b)(iii)).

³³ The flight path envelope is defined as follows:

Aircraft Altitude (ft in mean sea level (MSL))	Lower envelope boundary	Upper envelope boundary
> 29,000	25,000ft MSL or Flight Altitude minus 4,000ft, whichever is lower	60,000ft MSL or Flight Altitude plus 4,000ft, whichever is lower
29,000 – 6,000	Flight Altitude minus 4,000ft	Flight Altitude plus 4,000ft
< 6,000	Ground elevation or Flight Altitude minus 4,000ft, whichever is higher	10,000ft MSL

1.5.2.4 **Figure 11** shows the CP via which the Mode selection and GAIN knob can be set. The left half of the CP is used by the pilot seated on the left and the right half by the pilot seated on the right.

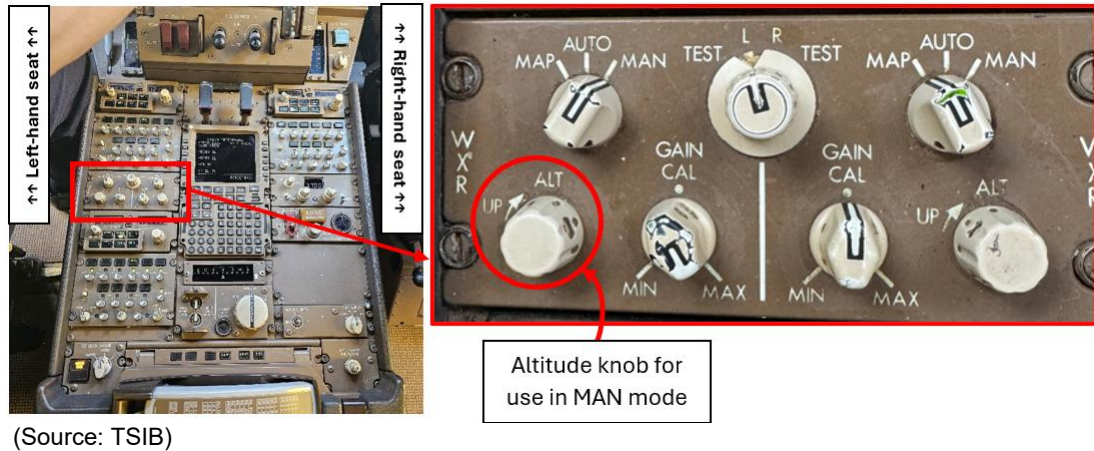

Figure 11: WXR control panel (CP)

1.5.2.5 The GAIN knob used by either flight crew member can be adjusted between MIN and MAX to vary the intensity of the weather return displayed on their respective ND, e.g. higher gain may change a green area into a yellow or even red area. The flight crew can adjust the GAIN knob to seek an optimum setting. There is a CAL (calibrated) detent position in the centre of the MAX-MIN control range. When the GAIN knob is out of the CAL detent, an annunciation in the form of a VAR (variable) text will appear on the ND.

1.5.2.6 The WXR system (WXR-L or WXR-R) can operate in either map (MAP), automatic (AUTO) or manual (MAN) mode.

- (a) In MAP mode, the WXR can identify terrain features, e.g. coastline, lakes and large built-up areas.
- (b) In AUTO mode (only the scenario corresponding to the cruising altitude of 37,000ft, which was the cruising altitude of the occurrence aircraft at the time of occurrence, is described below)
 - (i) The weather within the flight path envelope in front of the aircraft up to 320nm and between 4,000ft above and 4,000ft below the aircraft cruising altitude (i.e. between 41,000ft and 33,000ft) will be displayed as primary weather.

- (ii) The weather within the flight path envelope in front of the aircraft up to 320nm from 4,000ft above the aircraft (i.e. 41,000ft) up to 60,000ft will be displayed as secondary weather.
 - (iii) The weather within the flight path envelope in front of the aircraft up to 320nm from 4,000ft below the aircraft (i.e. 33,000ft) down to the ground level will be displayed as secondary weather except that, when there is convective weather from 33,000ft down to 25,000ft, the weather will be displayed as primary weather³⁴.
- (c) In MAN mode
- (i) The weather for the horizontal area in front of the aircraft up to 320nm and at the altitude selected via the Altitude knob will be displayed on the ND as primary weather.
 - (ii) Secondary weather will not be displayed.

1.5.2.7 The WXR OEM recommends that the WXR be operated in AUTO mode with GAIN knob set to CAL.

1.5.3 WXR maintenance records

1.5.3.1 According to the operator, out of about 29,000 B777 flights from May 2023 to July 2025, there were 103 flights with WXR-related issues reported (0.36% of the total number of flights during this period). The investigation team reviewed these 103 cases and noted the following breakdown

S/N	Entry	Number of cases
1	Display of incorrect weather information:	
	(a) Under-painting	12 (11.7%)
	(b) Over-painting	4 (3.9%)
	(c) No-painting ³⁵	20 (19.4%)
2	WXR system status message	56 (54.4%)

³⁴ This is based on a WXR capability known as the Convective Weather Discrimination which can determine if convective weather is present between surface and an altitude of 60,000ft.

³⁵ For the purpose of this report, 'no-painting' refers to a situation where there is no displayed weather returns on the ND, despite weather observed outside the cockpit.

S/N	Entry	Number of cases
3	WINDSHEAR system status message	3 (2.9%)
4	Altitude knob inoperative	2 (1.9%)
5	WXR inoperative	6 (5.8%)
	Total	103

Note: The WXR system does not generate fault messages in respect of S/N 1.

- 1.5.3.2 Two of the under-painting entries mentioned in S/N 1(a) of paragraph 1.5.3.1 pertained to WXR-R of the occurrence aircraft. The entries were logged on 29 April 2024 and 1 May 2024. WXR-R radar processor (RP) and transceiver (TR) were installed on the aircraft on 30 April 2018 and 12 April 2024 respectively.
- 1.5.3.3 One of the no-painting entries mentioned in S/N 1(c) of paragraph 1.5.3.1 was logged on 15 May 2024^Δ and pertained to WXR-R of the occurrence aircraft. During the flight when WXR-R was in use, there were no weather returns displayed when the flight crew observed convective clouds outside the cockpit. When the flight crew switched from WXR-R to WXR-L, weather returns were displayed on the ND.
- 1.5.3.4 In the three cases mentioned in paragraphs 1.5.3.2 and 1.5.3.3, the flight crews did not report seeing any WXR fault messages displayed³⁶. Post-flight maintenance actions were carried out on the occurrence aircraft in the form of a WXR system test as per the aircraft manufacturer's Aircraft Maintenance Manual (AMM) and the WXR-R passed the system test.
- 1.5.3.5 According to the aircraft manufacturer, the maintenance action for abnormal WXR painting issues is to perform a WXR system test as per the AMM. If the system passes the test, the WXR is considered serviceable. There are no other troubleshooting actions or tests required by the aircraft manufacturer. The WXR issues were also not required to be highlighted to the aircraft manufacturer.
- 1.5.3.6 The operator has a reliability programme that tracks recurring defects³⁷ for all aircraft systems, including WXR system. In addition to any applicable actions

³⁶ The WXR OEM analysed the data extracted from the non-volatile memory of the RP and TR of WXR-L and WXR-R of the occurrence aircraft and found no fault codes recorded for all these three flights.

³⁷ Under-painting, Over-painting and No-painting are considered to be the same type of defect, i.e. WXR painting issues.

^Δ "24" amended to "2024".

taken to resolve each defect that arises, when a same defect occurs to the same aircraft three times within 10 days, the operator will take additional troubleshooting actions as may be needed and monitor the aircraft for a similar defect. The investigation team noted that in the case of the occurrence aircraft, the three reports (two under-painting and one no-painting on the occurrence aircraft) did not occur within 10 days.

1.5.4 Operator's flight operations

1.5.4.1 The operator's guidance to its flight crews, on operating the aircraft, requires flight crews to use flight instruments to monitor aircraft systems and flight/navigation/terrain/weather situations. These flight instruments include the Primary Flight Display (PFD), ND and Engine Indications and Crew Alerting System (EICAS). The flight crew have their own PFD and ND whereas the EICAS display is located on the centre panel between the flight crew. In addition, the flight crews may look out from time to time (not all environmental conditions allow flights using visual references, for example, when flying in cloud or when flying at night).

1.6 Meteorological information

1.6.1 Turbulence

1.6.1.1 Aircraft in flight may be affected by convectively induced turbulence (CIT), clear air turbulence (CAT) or mechanical turbulence.

- (a) CIT is associated with convective clouds and thunderstorms and is generated by the movement of air into the storm, strong updrafts, downdrafts and outflow winds. CIT can exist outside cloud and may be encountered several thousands of feet above the cloud, and up to 20 miles laterally. CIT is common during warmer months in mid-latitudes and all year round in the tropics when thunderstorms develop.
- (b) CAT is typically associated with strong winds near jet streams at higher altitudes where strong vertical and horizontal windshear exists. CAT is common in winter months in mid-latitudes. CAT was not a factor in this occurrence.

- (c) Mechanical turbulence occurs when airflow encounters physical obstruction such as mountains or other terrain features, leading to turbulent air movement and vertical currents. This typically happens at lower altitudes close to terrain. Mechanical turbulence was not a factor in this occurrence.

1.6.2 Pre-flight briefing package

1.6.2.1 Before the flight crew departed Heathrow Airport on 20 May 2024, they received a pre-flight briefing package prepared by the operator. The package included a weather forecast map covering the flight route from Europe to Asia (see **Figure 12**). The flight crew noted the following from the weather forecast map:

- (a) No forecasted weather from Bulgaria to Bay of Bengal
- (b) No CAT over Myanmar
- (c) Occasional³⁸ cumulonimbus³⁹ (CB) and isolated⁴⁰ embedded⁴¹ cumulonimbus (CB) clouds from the south of Myanmar to Singapore

³⁸ Occasional – refers to CB cloud with maximum spatial coverage between 50% and 75% of the scalloped area in the weather forecast map.

³⁹ CB cloud is a heavy and dense cloud with a considerable vertical extent, in the form of huge towers. At least part of its upper portion is usually smooth, or fibrous or striated and nearly always flattened; this part often spreads out in the shape of an anvil or vast plume. *Source; World Meteorological Organization.*

⁴⁰ Isolated – refers to CB cloud with maximum spatial coverage less than 50% of the scalloped area in the weather forecast map.

⁴¹ Embedded – refers to clouds that are enclosed within other cloud layers and not readily recognisable.

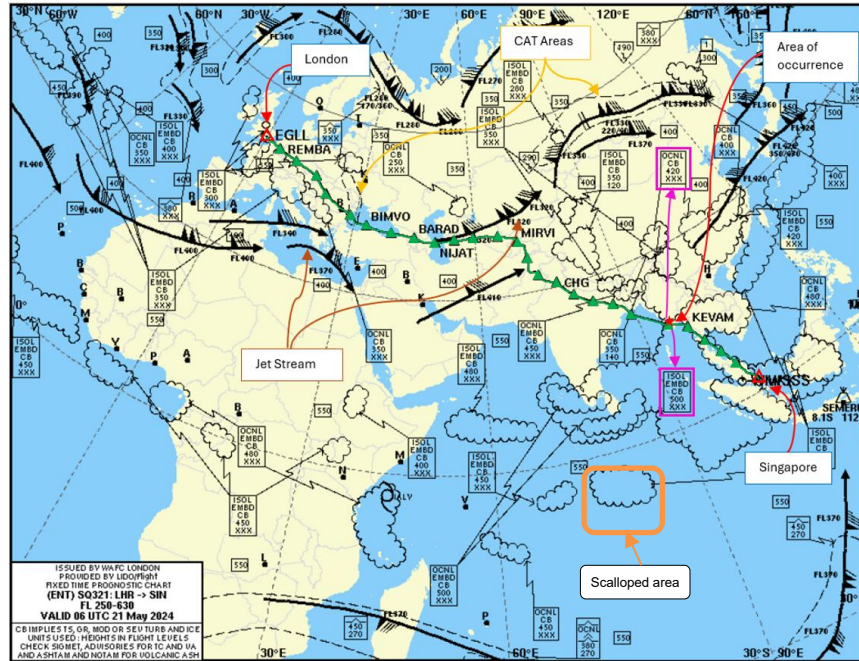

(Source: Operator) (Annotation: TSIB)

Figure 12: Weather forecast map covering the flight route from London to Singapore

1.6.3 Weather observations by other flight crews

1.6.3.1 Around the time of the occurrence, there were four aircraft operating in Myanmar airspace. The flight crews of the three aircraft approaching Myanmar from the west indicated that they were in VMC. The aircraft approaching Myanmar from the east was in Instrument Meteorological Conditions⁴² (IMC) at a lower altitude of 30,000ft.

1.6.3.2 The investigation team gathered the following information from these flight crews:

- (a) The cloud coverage in Southwest Myanmar was widespread. The flight crews visually estimated the cloud-top height to be in the range of 35,000ft – 50,000ft.
- (b) All four aircraft used a WXR system that was of a different model from the occurrence aircraft and weather returns were painted on their NDs.

⁴² In IMC, visibility is reduced and pilots will have to rely on flight instruments for navigation and control of aircraft, rather than visual references.

All four aircraft deviated from their planned routing to avoid weather cells. All four aircraft relied on WXR to circumnavigate the weather. They experienced light to moderate turbulence during the deviations.

- (c) All four aircraft were not at 37,000ft and were not on the same flight path as the occurrence aircraft, i.e. they did not fly over the occurrence location. These flight crews could not provide information on the clouds at the occurrence location.

1.6.4 Satellite weather data

- 1.6.4.1 In a meteorological report provided by the US National Transportation Safety Board (NTSB) to the investigation team, a Yangon ground WXR image at 07:42 was included. The WXR image depicts rainfall over Southwest Myanmar (see the left image in **Figure 13**). It shows that there was rainfall about 50nm inland of the west coast of Southwest Myanmar. The right image in **Figure 13** shows the satellite image at 07:40 depicting the cloud location corresponding to the rainfall image.

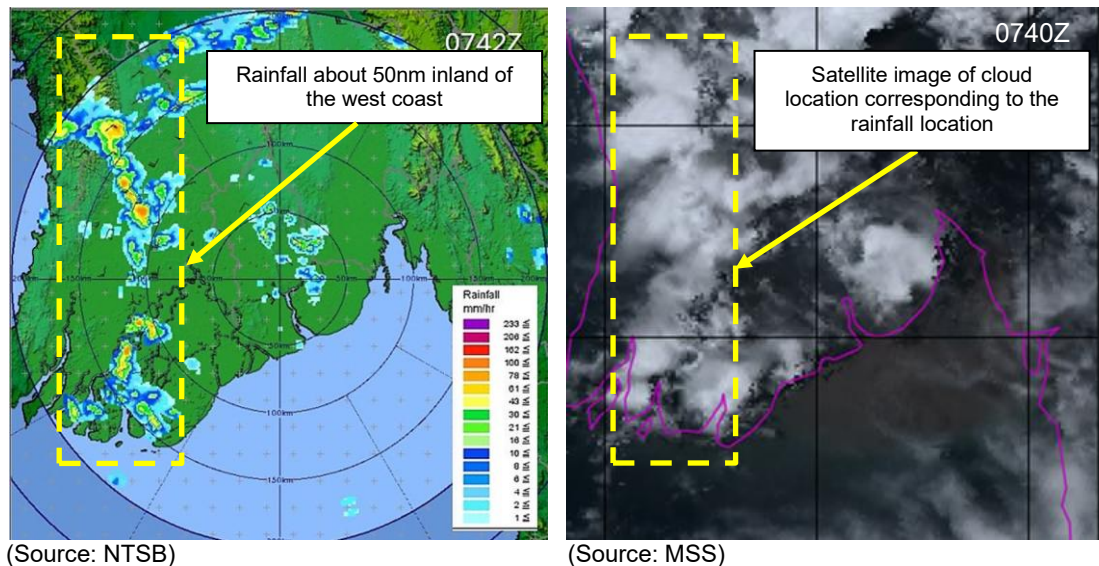

Figure 13: Ground WXR image (left) of rainfall and satellite image (right) inland of the west coast of Southwest Myanmar at 07:42 and 07:40 respectively

- 1.6.4.2 NTSB and the Meteorological Service Singapore (MSS) also provided Himawari-9 satellite images at 07:40 and 07:50 (see **Figure 14**). These images

show the weather over Southwest Myanmar at 07:40 and 07:50 (the turbulence incident occurred at about 07:49). It is to be noted that these satellite images provide only top-down views indicating the cloud coverage of the highest clouds. They do not provide information on the clouds' vertical profile (e.g. what is under the cloud tops, whether there are empty spaces under the layer clouds, and how low are the cloud bases).

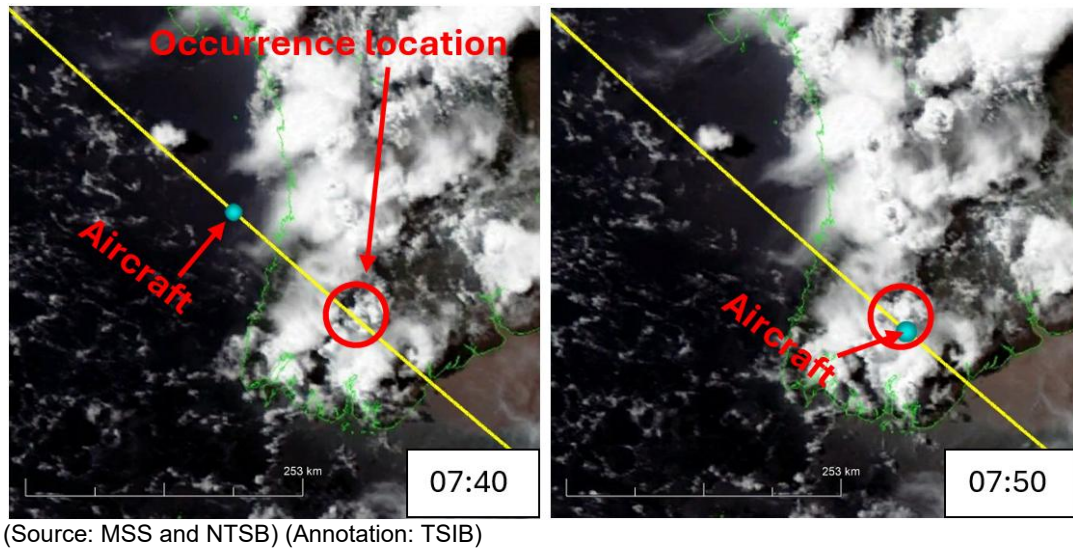

Figure 14: Occurrence aircraft location and cloud conditions

1.6.4.3 The investigation team noted from **Figure 14** that there were widespread clouds in the following two areas over Myanmar:

- (a) There were groups of clouds in Southwest Myanmar, including towering cumulus clouds⁴³ (TCU) about 50nm inland from the west coast of Southwest Myanmar (see paragraph 1.6.4.1) (hereinafter referred to as Cloud A.) There was rainfall associated with the TCU (see **Figure 13**). According to MSS' analysis of the satellite data, the cloud-top height in this area, from 07:40 to 07:50, was stable and was between 45,000ft and 52,000ft, which was above the aircraft cruising altitude. As mentioned in paragraph 1.6.3, the flight crews of the four aircraft then flying in the vicinity had similar observations.

⁴³ A towering cumulus cloud is a type of cumulus cloud that has developed significant vertical growth with a cloud base typically between 2,000 to 5,000ft from the ground, and is a precursor to a thunderstorm.

- (b) There were developing convective clouds at the occurrence location (hereinafter referred to as Cloud B.) According to MSS' analysis, the cloud-top height of Cloud B was about 27,500ft at 07:40. Cloud B then developed quickly over the next 10 minutes and the cloud-top height reached about 40,000ft at 07:50, i.e. the rate of increase of the cloud-top height was about 1,200ft/min.

1.6.4.4 NTSB also provided Himawari cloud-top height images at 07:40 and 07:50 (see **Figure 15**). These images show that there were clouds in the west coast of Southwest Myanmar, although, according to **Figure 13** above, there was no rainfall in the west coast. Similar to the satellite images, cloud-top height images do not identify the type of clouds that are covering an area and they do not provide information on the clouds' vertical profile.

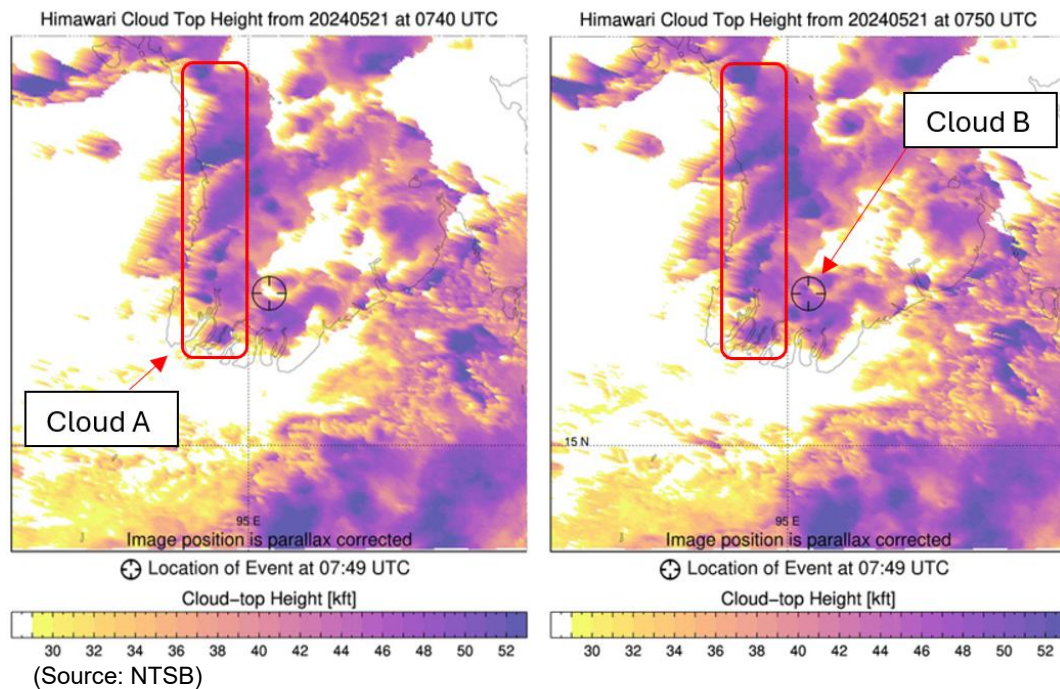

Figure 15: Himawari cloud-top height images at 07:40 and 07:50

1.6.4.5 The operator noted from the DFDR data in respect of the occurrence flight that, during the turbulence event, the occurrence aircraft had a 5 degrees nose-down pitch and yet was climbing at more than 2000ft/min. The operator used a B777-300ER flight simulator to try to understand the aircraft's behaviour. It observed that, with a 5 degrees nose-down pitch and in still air, an aircraft

would descend with a rate between 6000 and 7000ft/min⁴⁴. The operator postulated that the occurrence aircraft had likely passed over a fast-growing convective cloud at the occurrence location and encountered an updraft with a velocity of about 8,000 to 9,000ft/min. The operator further postulated that this location was a rapidly developing cumulus area⁴⁵ (RDCA). An independent review by the aircraft manufacturer based on B777-300ER aerodynamic data and aircraft kinematics provided an estimate that the maximum vertical wind speeds⁴⁶ at the occurrence location were about 150ft/sec (9000ft/min).

1.7 Flight recorders

1.7.1 The DFDR and CVR were removed from the aircraft after the occurrence and were read out by TSIB. The investigation team noted the following from the DFDR data:

Time	Event
07:48:58	<ul style="list-style-type: none"> • Aircraft in cruise at 37,000ft (FL370). • Pressure altitude was at 36,994ft. • Autopilot and autothrottle engaged. • Airspeed approximately at 0.84 Mach. • Pitch attitude approximately at +2.5 degrees (nose up) with wings level. • Vertical acceleration was around +1G
07:49:23	<ul style="list-style-type: none"> • Increasing fluctuation of flight parameters indicating the onset of turbulence. • Control deflection movements commanded by autopilot to maintain aircraft altitude. • Thrust adjustment by autothrottle to maintain the desired airspeed. • Pressure altitude⁴⁷ decreased slightly to 36,937ft before beginning to increase and vertical speed increased towards 1000 feet per minute. • Attitude began to pitch nose down to maintain FL370. • Pitch attitude approximately at +2.6 degrees (nose up). • Speed brake handle was moved from 'stow' to 'deploy'

⁴⁴ The operator's simulation was not able to consider the actual environmental conditions.

⁴⁵ An area of cumulus clouds that is growing vigorously and has the potential to quickly develop into cumulonimbus clouds (thunderstorms). This was diagnosed based on the Rapidly Developing Cumulus Area (RDCA) algorithm developed by the Japan Meteorological Agency.

⁴⁶ The vertical wind speed is not the same as the rate of increase of the cloud-top height.

⁴⁷ Pressure altitude refers to the height above a standard datum plane of a pressure reading of 1013.25 millibars.

Time	Event
	<ul style="list-style-type: none"> position. Vertical acceleration was about +1.2G.
07:49:25	<ul style="list-style-type: none"> Computed airspeed reached approximately 0.88 Mach⁴⁸ before decreasing. Speed brake handle was moved from 'deploy' towards 'stow' position.
07:49:31	<ul style="list-style-type: none"> Speed brake handle was again moved towards 'deploy'.
07:49:33	<ul style="list-style-type: none"> Speed brake handle moved towards 'stow' position.
07:49:35	<ul style="list-style-type: none"> Speed brake handle was fully stowed.
07:49:40	<ul style="list-style-type: none"> Vertical acceleration was at +1.35G. Pressure altitude was at 37,228ft. Attitude reached a pitch down angle of -5 degrees (nose down).
07:49:41	<ul style="list-style-type: none"> Vertical acceleration decreased towards -1.5G over a period of 0.6 seconds. Pressure altitude reached 37,362ft. A pull force on the right-seat column recorded 8 pounds and continued to increase. Angle of attack rapidly decrease. Pitch attitude at angle of -5 degrees (nose down) start to increase (nose up).
07:49:43	<ul style="list-style-type: none"> Vertical acceleration returned to near +1G. Pitch attitude increased to 0 degrees. Right-seat column force recorded 30.2 pounds of pull force with column deflection increasing to +0.5 degrees while continuing to increase. Autopilot Caution and Master Warning aural warning triggered and Autopilot disengaged.
07:49:46	<ul style="list-style-type: none"> Angle of attack reached approximately +6.5 degrees before beginning to decrease. As a result, stick shaker activated momentarily. A push on right-seat column with a force of 8 pounds. Vertical acceleration reached a local maximum of +1.76G before decreasing. Autopilot was briefly re-engaged. Pressure altitude decreased to 37,143ft.
07:49:47	<ul style="list-style-type: none"> Right-seat column push force recorded 32 pounds and as a result autopilot was disengaged again.

⁴⁸ Maximum operating Mach (MMO) is 0.89.

Time	Event
	<ul style="list-style-type: none"> Pitch attitude began to decrease from +6.5 degrees (nose up).
07:49:58	<ul style="list-style-type: none"> Pressure altitude reached 37,438ft before decreasing. Mach decreased to 0.81 Mach before starting to increase. Vertical acceleration decreased to +0.52G before increasing. Pitch attitude decreased to +1.23 degrees (nose up).
07:50:05	<ul style="list-style-type: none"> Autopilot re-engaged in Altitude Hold mode and autothrottle in SPD mode. Pitch attitude stabilised at +1.05 degrees (nose up). Decreased fluctuations in flight parameters and aircraft returned to stable condition. Pressure altitude was at 37,303ft. Vertical acceleration stabilised to around +1G.
07:50:23	<ul style="list-style-type: none"> Selected altitude (37,000ft) re-established. Vertical acceleration around +1G. Pitch attitude increased to +2.46 degrees (nose up).

1.8 Medical information

1.8.1 The flight crew were not sent for medical and toxicological examinations.

1.9 Survival aspects

1.9.1 The cockpit and cabin seats were inspected after the occurrence. There was no evidence of pre-existing defects in the cockpit and cabin seat structure. The cockpit and cabin seat belts were also found to be in working condition.

1.10 Additional information

1.10.1 In-flight WXR system check

1.10.1.1 On 26 May 2024, the occurrence aircraft was ferried from Bangkok to Singapore by another set of flight crew. During the ferry flight, the flight crew performed an in-flight check on WXR-L and WXR-R as requested by the WXR OEM. The steps of the in-flight check as suggested by the WXR OEM were as follows:

- (a) When a WXR system (WXR-L or WXR-R) is operating in MAP mode (where terrain returns are displayed), take photos of the display of the terrain returns shown on the NDs;
- (b) Switch to the other WXR system, wait for five minutes (for the terrain database to be built up) and take photos of the display of the terrain returns shown on the NDs; and
- (c) Compare the two sets of photos.

1.10.1.2 The photos taken by the flight crew indicated that the WXR-R was under-painting when compared with WXR-L (see **Figure 16**).

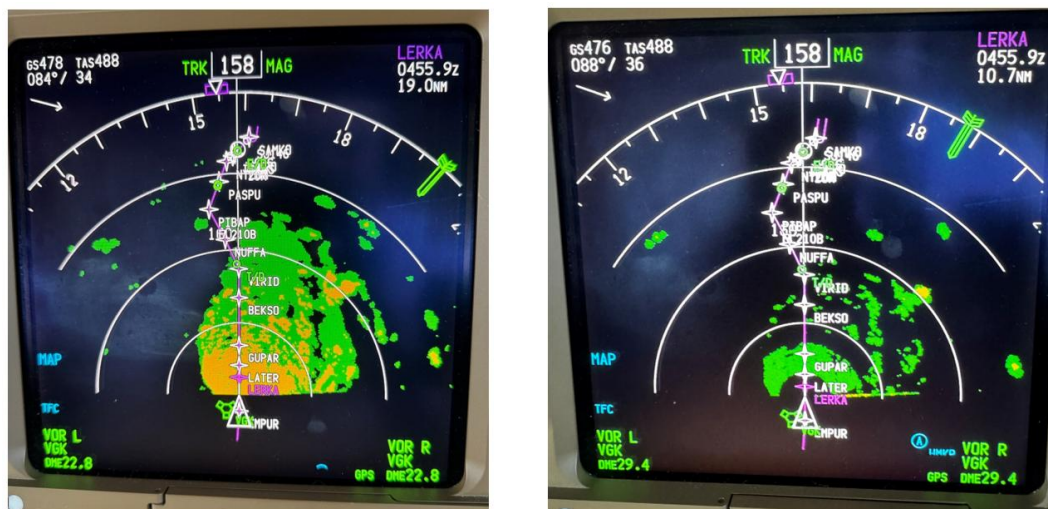

(Source: Operator)

Figure 16: Comparison of WXR-L (left photo) and WXR-R (right photo) during in-flight WXR system check

1.10.1.3 The investigation team noted that, in executing the in-flight check as suggested by the WXR OEM, the flight crew had made a variation to the steps suggested by the WXR OEM. During the execution of the step (b) of the check, the flight crew, on their own initiative, took photos of the terrain returns shown on the NDs one minute after switching from WXR-L to WXR-R. After a further four minutes (by when the terrain database would have been built up), the flight crew observed that the terrain returns displayed on the NDs were similar to the display four minutes earlier (i.e. WXR-R was still under-painting). The flight

crew exercised their judgement and decided there was no need to take photos of the display on the NDs again.

1.10.1.4 According to the WXR OEM, the photo taken at one minute is not representative of the relative system performance between WXR-L and WXR-R as it takes five minutes for the full cycle of WXR to populate the weather database.

1.10.1.5 After the ferry aircraft arrived in Singapore, fault codes from both RPs were downloaded. These fault codes corresponded to the faults recorded in the last 64 flights (which included the occurrence flight). The downloaded data files were presented to the WXR OEM for analysis and showed no fault for both RPs.

1.10.2 Tests carried out by WXR OEM

1.10.2.1 The flight crew of the occurrence flight after arrival in Bangkok, informed the investigation team that the NDs did not show any weather returns prior to the turbulence event and during descent to FL310 (see paragraph 1.1.23). The NDs showed weather returns after the aircraft had descended below FL310. As mentioned in paragraph 1.5.3, the maintenance records indicate there is an intermittent issue of WXR under-painting and no-painting within the operator's fleet of aircraft and in footnote 49 the WXR OEM had prior issues of under-painting that resulted in the recall of WXR within a certain batch that was captured in a Service Information Letter (SIL) to the industry. The investigation team decided to have the WXR system examined and tested for the purpose of determining if there were any hardware failures or conditions that would have prevented normal operation of the WXR system.

1.10.2.2 The following WXR system components of the occurrence aircraft were sent to the WXR OEM for tests and examination:

- (a) WXR-L and WXR-R transceivers (TRs)
- (b) WXR-L and WXR-R radar processors (RPs)
- (c) Antenna drive unit (DA)
- (d) Radar antenna
- (e) WXR control panel (CP)

1.10.2.3 The above components are hereinafter referred to as occurrence components, occurrence radar antenna, occurrence TRs, etc.

1.10.2.4 The WXR OEM first carried out a WXR Transmission and Reception Operational Test to assess the performance of the occurrence components as a whole. The investigation team observed the test.

- (a) For the purposes of the test, a WXR system was reconstituted from the occurrence components (this reconstituted WXR system is hereinafter referred to as the occurrence WXR). The WXR transmission and reception operational test was to compare the performance of the occurrence WXR with the performance of a reference WXR unit (RU) of the WXR OEM.
- (b) According to the WXR OEM, the occurrence WXR performed within expected limits, as compared to the RU.
- (c) However, the investigation team noticed that the occurrence WXR revealed some over- and under-painting issues, but the WXR OEM opined the WXR operated within specifications (see paragraph 2.5.1).

(Details of the WXR transmission and reception operational test are in paragraph A1 of **Appendix**.)

1.10.2.5 For the individual occurrence components, the WXR OEM carried out the following tests.

S/N	Occurrence component	Test	Purpose of test
1	CP, DA, RPs, TRs	Test using Acceptance Test Procedure (ATP)	To verify that the occurrence components met their performance requirements as designed by the component manufacturers
2	CP	Test using Integration Test Procedure (ITP)	To determine the performance of the CP when integrated into the WXR system

3	DA, TRs	Temperature cycle test	To assess if the occurrence DA and TRs met their design criteria when exposed to temperatures ranging from -55°C to +70°C (Note: The DA and TRs are installed in the radome, which is outside the pressurised area, which is not heated).
4	TRs	Highly Accelerated Stress Screen test (HASS)	To determine if the occurrence TRs had an issue with TR diodes. (Note: The WXR OEM had previously identified issues of WXR under-painting caused by TR diodes.)
5	WXR-L, WXR-R	Flight test	To assess the in-flight performance of the occurrence WXR system components.

- 1.10.2.6 The investigation team observed all the above tests except the CP ATP test (S/N 1) and the HASS test (S/N 4) which were witnessed by the NTSB on behalf of the investigation team.
- 1.10.2.7 The WXR OEM carried out tests in accordance with the Acceptance Test Procedure (ATP) to verify that the occurrence components met their performance requirements as designed by the component manufacturers. The occurrence CP, DA, TRs and RPs passed the tests (details of the test are in paragraph A2 of **Appendix**).
- 1.10.2.8 The WXR OEM carried out a test on the occurrence CP in accordance with the Integration Test Procedure (ITP) to determine the performance of the CP when integrated into the occurrence WXR system. The test found that the VAR text was displayed on the ND even when the GAIN knob was in the CAL position (i.e. 12 o'clock position). (Note: Normally, the VAR text will be displayed on the ND when the GAIN knob is not in the CAL position). The WXR OEM postulated

- that the CP could have an intermittent issue but could not explain or determine the cause of the issue (details of the test are in paragraph A3 of **Appendix**).
- 1.10.2.9 The WXR OEM carried out a temperature cycle test to assess if the occurrence DA and TRs met their design criteria when exposed to temperatures ranging from -55°C to +70°C.
- (a) The DA exhibited unusual performance characteristics in the scanning pattern (i.e. pan and tilt) of the antenna at temperatures between -31°C and -55°C and varying durations.
 - (b) The irregular scanning pattern at lower temperature conditions was accompanied by a fault indication and reverted to normal scanning when the temperature subsequently increased with the exact temperatures varying depending on the test configuration.
- 1.10.2.10 The WXR OEM repeated the temperature cycle test using the estimated actual occurrence flight temperature experienced and the DA passed the modified test. The WXR OEM opined that the unusual scanning did not happen during the occurrence flight as the modified temperature cycle test did not exhibit unusual scanning behaviour and there were no fault codes relating to unusual scanning of the DA (details of the test are in paragraph A4 of **Appendix**).
- 1.10.2.11 The WXR OEM carried out flight tests to assess the in-flight performance of the occurrence components. The investigation team observed the flight tests. Normally, the VAR text would only be displayed when the GAIN knob was not in the CAL position but during the flight test it was found that:
- (a) the VAR text was displayed even when the GAIN knob was in the CAL position; and
 - (b) the VAR text disappeared when the GAIN knob was in the 2 o'clock position.
- 1.10.2.12 The WXR OEM opined that the GAIN knob could be outputting an incorrect gain value, such that the ND would indicate the VAR text even when the GAIN knob was in the CAL position. However, the CP passed a second ITP test after the flight test without undergoing any rectification or adjustments. The WXR OEM postulated that there could be an intermittent fault with the CP (details of the flight tests are in paragraph A8 of **Appendix**).

- 1.10.2.13 The WXR OEM had previously come across some defective diodes⁴⁹ in some TRs which can appear to be operating normally but underpainting the detected weather. The WXR OEM carried out a Highly Accelerated Stress Screen (HASS) test to determine whether the occurrence left and right TRs had an issue with TR diodes. The test was conducted at the premises of the TR OEM. The test was witnessed by the NTSB on behalf of the investigation team. The test on the occurrence right TR, which was in use at the time of the occurrence, showed that the right TR response was normal. The occurrence right TR diode passed the test.
- 1.10.2.14 The WXR OEM concluded that the TRs functioned normally as no fault was found in either of the accident TRs (details of the HASS test are in paragraph A5 of **Appendix**).
- 1.10.2.15 The investigation team observed the disassembly of the occurrence TR-R for visual inspection of the printed circuit board and diodes under a high-resolution microscope (see A6 of **Appendix**).
- (a) No assembly issue was identified.
 - (b) No defective diodes were found.
 - (c) The inspection of the diode identified superficial scratches on the surface but did not identify areas of concern.
- 1.10.2.16 Additional tests and examinations were carried out on the occurrence DA. The NTSB observed the test on behalf of the investigation team. Both Ribbon 1 and Ribbon 2 triggered the illumination of the red ground-chassis continuity LED on the cable test bench, indicating a short. Although wear and an exposed conductor on Ribbon 1 were found when the DA was disassembled for inspection, the WXR OEM considered them as normal wear and that they would not affect the performance of the occurrence DA. Ribbon 1 did not contribute to any potential no-painting or under-painting of the weather during the occurrence flight, given that it was not active during the occurrence flight. Ribbon 2 had no exposed conductors, however it still triggered the illumination of the red ground-chassis continuity LED on the cable test bench. The cause of this LED illumination was not determined. According to the WXR OEM, although Ribbon 2 was active during the accident flight, and no exposed

⁴⁹ The WXR OEM had issued a Service Information Letter (SIL) D202312004206 which inform operators that some batches of TRs can appear to be operating normally but is underpainting the actual weather. The occurrence TRs were not part of the identified batches mentioned in this SIL.

conductor was found, Ribbon 2 cable did not contribute to any potential no-painting or under-painting of weather returns during the occurrence flight as the RF signal is not transmitted through this cable (details of the test and examination are in paragraph A10^Δ of **Appendix**).

1.10.2.17 According to the WXR OEM, it also examined the non-volatile memories of the occurrence RPs and TRs. No fault codes had been registered by the occurrence RPs. While the occurrence TRs had registered fault codes, they were not related to the occurrence flight and ferry flight.

^Δ "A7" amended to "A10".

2 ANALYSIS

The investigation team looked into the following:

- (a) The turbulence event
- (b) Flight crew's visual observation of environmental conditions
- (c) Possibility of no-painting of occurrence aircraft WXR
- (d) Issue of under-painting of occurrence aircraft WXR
- (e) Non-normal behaviour of WXR system tests at OEM facility
- (f) Troubleshooting WXR defects using the maintenance manual
- (g) Performance of aircraft WXR
- (h) Weather information recordings
- (i) Fastening of seat belt

2.1 The turbulence event

2.1.1 Waypoint PTN was about 135nm east of Location Z and the turbulence occurrence location was about 30nm further east of PTN or about 165nm from Location Z (this was within the detectable range of the WXR of up to 320nm). As mentioned in paragraph 1.6.4.3, there were two groups of clouds, Cloud A and Cloud B. The cloud-top heights of Cloud B at the occurrence location at about 07:40, were about 27,500ft. As the flight progressed, Cloud B developed over a period of 10 minutes into a TCU with a cloud top height of about 40,000ft, i.e. the rate of increase of the cloud-top height was about 1,200ft/min. The turbulence experienced by the aircraft was likely the result of this rapidly growing cloud which could cause significant vertical air movements such as updrafts and downdrafts associated with CIT.

2.1.2 As mentioned in paragraph 1.6.4.5, the operator and aircraft manufacturer had each carried out an independent review:

- (a) The operator postulated that the occurrence aircraft had likely passed over fast-growing convective clouds at the occurrence location and encountered an updraft with a velocity of about 8,000 to 9,000ft/min.
- (b) The aircraft manufacturer used flight recorder data to estimate that the maximum vertical wind speeds at the occurrence location were about

150ft/sec (9000ft/min), which is comparable to the updraft velocity estimated by the operator.

- 2.1.3 As indicated in Footnote 46 of paragraph 1.6.4.5, the vertical windspeed and rate of increase of cloud-top-height do not measure the same thing. However, one aspect is consistent: there were significant vertical air movements associated with turbulence, as indicated in paragraph 2.1.1.
- 2.1.4 Faced with the unexpected turbulence event, the actions of the flight crew are understandable and appropriate for the situation, i.e. as mentioned in paragraph 1.1.15, when the aircraft experienced the change in G force from +1.5G to -1.5G, the flight crew initiated manual control inputs to stabilise the aircraft. The flight crew manually flew the aircraft for 21 seconds before they reengaged the autopilot.
- 2.2 Flight crew's visual observation of environmental conditions
 - 2.2.1 When operating under IFR, it is not uncommon for a flight crew to focus on the flight instruments during the cruise phase of flight and look out of the cockpit window occasionally. This is unlike when the aircraft is closer to the ground (e.g. for landing) and the flight crew may have to look out for visual references more often to assess the environment as they descend towards the airport.
 - 2.2.2 On the one hand, when the aircraft was at Location Z, some 165nm from the turbulence location, the flight crew of the occurrence flight saw some cirrus clouds in the distance, but the immediate flight path was clear. The flight crew said that their NDs had not been showing any weather returns from Location Z. This is consistent with the CVR recording between the PIC and AGP where there was no discussion or mention about weather.
 - 2.2.3 On the other hand, the weather information in paragraph 1.6.4 suggests that there was widespread cloud coverage in Southwest Myanmar around the time the occurrence aircraft was flying through the area. There were four other aircraft flying in the vicinity (see paragraph 1.6.3) and the flight crews of these aircraft saw widespread clouds. However, their flight paths were not the same as the occurrence aircraft, and their accounts were about the general condition of the weather over Myanmar and not that over the occurrence location. The investigation team is unable to understand why the flight crew of the occurrence flight did not see the widespread clouds.

2.3 Possibility of no-painting of occurrence aircraft WXR

2.3.1 As mentioned earlier, the investigation team believes that there was widespread cloud coverage in Southwest Myanmar, including TCU and rain clouds, around the time the occurrence aircraft was flying through the area. The Yangon WXR images (see **Figure 13**) shows rainfall, ranging from 1 to 100mm/hr, in the area about 50nm inland of the west coast of Southwest Myanmar. According to the WXR OEM, their WXR can detect rainfall above 0.7mm/hr which would be painted on the NDs. These clouds were within the detection range of the WXR. Yet, the flight crew told the investigation team that the NDs of the occurrence aircraft did not show any weather returns. Summarised below are the flight crew's observations on the NDs:

- (a) When the aircraft was at Location Z (about 135nm from PTN and 165nm from the occurrence location) at 07:30, the flight crew did not observe any weather returns on the NDs (see paragraphs 1.1.5 and 1.1.6).
- (b) When turbulence occurred at about 07:49, the flight crew still did not observe any weather returns on the NDs (see paragraph 1.1.17).
- (c) When the aircraft was descending from FL370 to FL310, the flight crew observed that there were no weather returns on their NDs (see paragraph 1.1.23).

2.3.2 The investigation team opined that the flight crew's account of no WXR returns shown on the NDs are credible based on the following:

- (a) From the DFDR, it shows that the AGP was adjusting the ND range (see paragraph 1.1.11). Had there been any WXR returns on the ND, it is likely that the AGP would have discussed the weather with the PIC. However, there was no verbal communication recorded in the CVR between the PIC and AGP about weather.
- (b) After the turbulence event, the CVR recorded the PIC expressing surprise that he did not see any weather returns on the ND even though he had the GAIN knob set to MAX.

2.3.3 In addition, the investigation team reviewed the operator's B777 fleet maintenance records from May 2023 to July 2025 and noted that out of about 29,000 flights, there were 20 reports. Of the 20 reports, one logged on 15 May 2024 pertaining to the occurrence aircraft, of no-painting of the WXR-R system

without fault messages. It is likely that the occurrence aircraft experienced another no-painting situation on its WXR-R.

2.4 Issue of under-painting of the occurrence aircraft WXR

2.4.1 The in-flight WXR system check carried out during the ferry flight from Bangkok to Singapore suggests that the WXR of the occurrence aircraft might have an under-painting issue, as observed by the flight crew operating the ferry flight.

2.4.2 The flight crew did not follow the WXR OEM's instruction to take a photo five minutes after switching from WXR-L to WXR-R to allow for a full scan cycle. The flight crew had taken a photo about one minute after switching WXR-L to WXR-R. They did not take another photo after five minutes as they noted that there was no difference in what was displayed on the ND five minutes after switching and therefore, they did not see the need to take another photo. The WXR OEM's view is that, since the ferry flight crew did not have photographic evidence taken in accordance with its instructions, the in-flight test result of the WXR systems was not valid and could not be used to infer on the performance of WXR-R versus WXR-L.

2.4.3 A review of the operator's B777 fleet maintenance records from May 2023 to July 2025 showed that out of about 29,000 flights, there were 12 reports, including two logged on 29 April 2024 and 1 May 2024 pertaining to the occurrence aircraft, of under-painting of the WXR system without fault messages in the cockpit.

2.4.4 Notwithstanding the WXR OEM's view in 2.4.2, the investigation team opines that, taking into consideration the maintenance records, the ferry flight crew's observation of under-painting does suggest an issue of under-painting of the WXR.

2.5 WXR system tests at OEM facility

2.5.1 A series of examination and tests were carried out (see paragraph A1 in **Appendix**) to determine if there were any hardware failures or conditions that would have prevented normal operation of the WXR system. The WXR OEM could not find any hardware issues during the tests. However, the investigation team has noted some unusual behaviour during the following tests:

- (a) The WXR Transmission and Reception Operational Test
- (b) Temperature cycle test
- (c) ITP and flight test of CP

2.5.2 As regards to the WXR Transmission and Reception Operational Test (see paragraph A1 in **Appendix**), the test showed that, at the 40nm range setting⁵⁰, the WXR was underpainting test targets at 20nm range directly ahead of the WXR⁵¹ and overpainting test targets to the side of the WXR⁵² as compared to the RU. According to the WXR OEM, the difference between green and black can be as little as 1 dBz and was within normal limits. The WXR OEM assessed that the results do not support a characterisation of underpainting. The investigation team has reservations about the explanation as the WXR OEM examination report states that the occurrence aircraft WXR systems were more reflective (overpainting) but showing less terrain 20nm ahead of the WXR. The WXR OEM could not explain why the occurrence aircraft WXR was overpainting and underpainting the test targets within the scanning field of view.

2.5.3 As regards to temperature cycle test of the DA and TRs, the scanning pattern of the DA was erratic at cold temperatures. The WXR OEM stated that such behaviour would have resulted in a fault message being displayed on the NDs. The WXR OEM opines that since the flight crew did not report any fault messages during the occurrence flight this erratic behaviour was unlikely to have occurred. The WXR OEM could not determine the cause of the repeated DA erratic scanning behaviour.

2.5.4 As regards ITP and flight test of CP, the VAR text appeared when the right GAIN knob was in CAL position. However, the CP OEM considered the unit to be within specification limits during the ATP and did not find any issues. The WXR OEM believes the occurrence CP right GAIN knob could have an intermittent issue but could not explain the cause of the CP intermittent issue.

2.5.5 The investigation team believes that the non-normal behaviours mentioned in paragraphs 2.5.3 and 2.5.4 did not happen during the occurrence flight and ferry flight. There were no fault messages relating to DA erratic scanning during these flights. The AGP observed that there was no VAR text displayed on the

⁵⁰ The operational test did not increase the range beyond 40nm. Normally at cruise altitude the WXR range setting is greater than 40nm.

⁵¹ The RU showed a green return at 20nm whereas the occurrence WXR showed no return, i.e. black.

⁵² The RU showed green and amber return at 20nm to the left of the field of view whereas the occurrence WXR showed a green, amber and red return.

ND during the occurrence flight, and the ferry flight ND photos also did not have the VAR text displayed, when the GAIN knob was in CAL position (see **Figure 16**).

2.5.6 The WXR OEM concluded from the WXR tests that there was no evidence that the occurrence WXR did not accurately detect and display the weather encountered as the aircraft overflew Southwest Myanmar, or at any other time during the occurrence flight. However, in view of paragraphs 2.3 and 2.4, the investigation team opines that the possibility of no-painting and under-painting without fault messages cannot be ruled out.

2.6 Troubleshooting WXR defects using the maintenance manual

2.6.1 When there were reports of under-painting or no-painting of the WXR, the engineers typically performed the test⁵³ in accordance with the aircraft maintenance manual (AMM). The AMM did not have specific guidance to troubleshoot an under-painting or no-painting report. In all cases, when the WXR passed the AMM test, the reports were closed and no further action was considered necessary. However, there were occasions where the under-painting or no-painting faults were reported again in subsequent flights.

2.6.2 The investigation team noted that the AMM test has a limitation in that it cannot replicate the conditions which the WXR was exposed to during flight. Neither was the AMM test able to identify the fault contributing to the WXR under-painting or no-painting.

2.6.3 The investigation team opines that the AMM test is only able to check the integrity of the WXR but was unable to identify issues relating to no-painting or under-painting. With such limitations and given that the proper functioning of the WXR is important in circumnavigating weather, the investigation team opines that it is important for the aircraft manufacturer to:

- (a) develop a procedure for flight crews to check on the proper functioning of the WXR in use;
- (b) enhance the troubleshooting procedure in the AMM pertaining to under-painting and no-painting of WXR; and

⁵³ The ground system test of the WXR checks that the WXR hardware, processing, displays and windshear warning system are working properly, using a test pattern and simulated alerts, without radiating normal radar energy outside the aircraft.

- (c) be informed of any under-painting and no-painting issues that operators have encountered so that the aircraft manufacturer can address them.

2.7 Performance of aircraft WXR

2.7.1 In addition to paragraph 2.5.6, given that there were reports of WXR under-painting or no-painting by various flight crews on B777-300ER aircraft of the operator, including one report of no-painting and two reports of under-painting on the occurrence aircraft, the investigation team believes that the WXR under-painting or no-painting without fault messages in the cockpit cannot be ruled out.

2.7.2 The WXR is an important tool for flight crew to avoid weather. The weather information displayed to the flight crew shows the intensity of the precipitation to assist the flight crew in deciding the best path to navigate in area of adverse weather. This occurrence serves as an advisory to flight crews that WXR under-painting and no-painting situations can occur without fault messages in the cockpit and they should, whenever possible, closely compare external visual cues with ND weather returns.

2.8 Weather information recordings

2.8.1 The data and information from the NTSB meteorological report, Himawari satellite images, Yangon ground weather radar images and the statements from the flight crews of four other flights flying over Southwest Myanmar at about the same time as the occurrence flight indicated that there was widespread weather over Southwest Myanmar. However, the WXR-R did not display any weather returns as reported by the flight crew of the occurrence flight. The investigation team was unable to review what the flight crew saw, or would have seen, on the NDs.

2.8.2 Currently, ICAO Annex 6 to the Convention on International Civil Aviation concerning the installation of FCMIR⁵⁴ is only applicable to aircraft with a maximum take-off mass of over 27,000kg that are type certificated after 1

⁵⁴ A function that records information displayed to the flight crew as well as switches and controls used by them to operate the aircraft. A recording may comprise one or more types of data such as those captured by images and flight data recorders or other formats appropriate to specific interface.

January 2023. The investigation team believes that there is value in extending the FCMIR requirement to aircraft, in the same mass category, that are type certificated before 1 January 2023 to better improve aviation safety.

2.8.3 Had the occurrence aircraft been installed with an airborne image recorder that could provide FCMIRs, the investigation team would have a means to assess what the flight crew saw, or could have seen, on their NDs. Alternatively, the WXR OEM could consider developing a means for recording images of weather information displayed to flight crews. This information can be used by maintenance crew to rectify under-painting and no-painting issues. These recordings are also useful for turbulence related investigations.

2.9 Fastening of seat belt

2.9.1 As mentioned in paragraph 1.1.13, the PIC switched on the fasten-seat-belt sign after the aircraft experienced the onset of turbulence. It cannot be over-emphasised that fastening of seat belt is an effective way of preventing injuries when an aircraft encounters turbulence. When one becomes airborne during turbulence and falls back down, in addition to injuring oneself, one might also injure other passengers. This occurrence serves as a reminder for all passengers, that turbulence may hit suddenly without warning, to always fasten their seat belts while seated and to refrain from moving about in the cabin unnecessarily, even when the fasten-seat-belt sign is off.

3 CONCLUSIONS

From the information gathered, the following findings are made. These findings should not be read as apportioning blame or liability to any particular organisation or individual.

3.1 Turbulence event

3.1.1 The aircraft had encountered severe convective induced turbulence when flying over Southwest Myanmar.

3.1.2 The satellite and cloud-top height images and Yangon ground WXR images showed there were widespread clouds coverage over Southwest Myanmar as the occurrence aircraft was approaching the west coast of Southwest Myanmar. According to the flight crew, they did not see any clouds.

3.1.3 Prior to the turbulence event, there was no verbal communication recorded in the CVR between the PIC and AGP about weather. After the turbulence event, the PIC was surprised as there were no clouds observed nor weather returns on the ND even though he had set the GAIN knob to MAX.

3.2 WXR issues

3.2.1 There had been reports of under-painting or no-painting of the WXR prior to the occurrence flight. There were also indications that the WXR was under-painting during the ferry flight from Bangkok to Singapore after the occurrence flight.

3.2.2 After departure from London, WXR appeared to be operating normally. Prior to the turbulence event, the NDs were not showing any weather returns. Weather returns were shown on the NDs after descending below FL310. The investigation team opines that the WXR was painting weather returns intermittently during the occurrence flight and that the possibility of no-painting and underpainting of WXR cannot be ruled out in view of the maintenance records and what was observed during the ferry flight.

3.2.3 Extensive tests were carried out on the occurrence aircraft WXR system. According to the WXR OEM, there was no evidence that the WXR was not detecting and displaying the weather encountered during the occurrence flight. However, the investigation team noted that there were some unusual behaviours during the tests.

- 3.2.4 As the WXR does not generate any fault message during an under-painting or no-painting situation, flight crews may not be aware when the WXR is not functioning properly.
- 3.3 WXR ground test procedures
 - 3.3.1 The test prescribed in the AMM only checks for system integrity but is unable to identify the issues relating to under-painting or no-painting.
 - 3.3.2 The under-painting and no-painting issues were not required to be referred to the aircraft manufacturer and the WXR OEM.
- 3.4 Recording of WXR information
 - 3.4.1 The WXR, on existing aircraft, does not record the weather returns displayed to flight crews.
 - 3.4.2 ICAO requires the installation of FCMIR for aircraft with a maximum take-off mass of over 27,000kg that are type certificated after 1 January 2023. There is value in extending the FCMIR requirement to aircraft, in the same mass category, type certificated before 1 January 2023 to better improve aviation safety.
- 3.5 Fastening of seat belt
 - 3.5.1 This occurrence serves as a reminder that passengers should always fasten their seat belts while seated even when the fasten-seat-belt sign is not switched on.

4 SAFETY ACTIONS

Arising from the occurrence, the operator has taken the following safety actions.

4.1 The operator has taken the following safety actions:

- (a) Enhanced its turbulence monitoring and awareness tools which are installed in electronic tablets provided to its flight crew by:
 - (i) Enabling the Eddy Dissipation Rate (EDR)⁵⁵ data display in the eWAS⁵⁶ application;
 - (ii) Introducing a weather layer in the eWAS application, to help forecast RDCA;
 - (iii) Introducing SkyPath application, to detect, predict and help avoid turbulence during flights.
- (b) Refresher training
 - (i) Weather radar refresher training was conducted for all flight crews for all the operator's fleet of aircraft (which included the OEM WXR system) from July to December 2024;
 - (ii) e-Learning module on turbulence management that was part of the Safety and Emergency Procedure training for both flight crew and cabin crew was created and completed by all flight crews to refresh line pilots' knowledge;
 - (iii) e-Learning courseware on turbulence management was introduced to cabin crew to reinforce key safety precautions and action during turbulence weather;
 - (iv) Scenario-based training on turbulence management was reinforced in the Cabin Crew Resource Management training to refresh cabin crew's knowledge.
- (c) Enhancement of training

⁵⁵ EDR is an atmospheric turbulence intensity metric based on the rate at which energy dissipates in the atmosphere. The effect of the EDR value on the aircraft will depend on the size (weight) of the aircraft. For example, for the same EDR value, the turbulence may be regarded as moderate intensity for a B737 whereas it may be regarded as light for a heavier category aircraft.

⁵⁶ eWAS – Electronic Weather Awareness System is an application provided to flight crew for weather monitoring.

- (i) A workshop programme has been developed for new cabin crew trainees to emphasise the safety practices that can prevent them from being injured during turbulence.
- (d) Enhancement to procedures
 - (i) The in-flight entertainment system will display reminders to passengers periodically to fasten seat belts when seated.
 - (ii) Pilots will emphasise fastening of seat belt when seated during their welcome announcement.
 - (iii) Turbulence announcement whenever seat belt sign is switched on will now be made by the pilot-in-command in addition to the announcement made by the cabin crew.
- (e) Enhancement to guidance on WXR in the form of a technical bulletin:
 - (i) informed its flight crews of the potential issues of WXR under-painting or no-painting without fault messages.
 - (ii) provided guidance to its flight crews on how to troubleshoot suspected issues of WXR under-painting or no-painting.
- (f) Operator has started to send reports of WXR under-painting and no-painting issues on its B777-300ER fleet to the aircraft manufacturer and WXR OEM for information and follow-up actions.

5 SAFETY RECOMMENDATIONS

A safety recommendation is for the purpose of preventive action and shall in no case create a presumption of blame or liability.

- 5.1 It is recommended that the aircraft manufacturer develop guidance for flight crews to ascertain whether a WXR is under-painting or no-painting during a flight as well as the corrective actions for flight crews to take. [TSIB RA-2026-002]
- 5.2 It is recommended that the aircraft manufacturer provide guidance for maintenance personnel to identify under-painting or no-painting issues of WXR system. [TSIB RA-2026-003]
- 5.3 It is recommended that the WXR OEM develop a means for recording images of weather information displayed to flight crews to aid rectification of under-painting or no-painting issues. [TSIB RA-2026-004]
- 5.4 It is recommended that the International Civil Aviation Organization require aircraft with a maximum take-off mass of 27,000kg and above that are type certificated before 1 January 2023 to install FCMIR. [TSIB RA-2026-005]

Remarks/Notes by the Investigation Team

A1 WXR Transmission and Reception Operational Test

A1.1 The test compared the performance of the occurrence WXR (as reconstituted from all the occurrence components of the WXR system of the occurrence aircraft that had been sent to the WXR OEM for testing) with the performance of a reference WXR unit (RU) of the WXR OEM.

A1.2 The test was conducted at a testing ground of the WXR OEM. The testing ground comprised certain terrain features, which had names as shown in **Figure 17**. They served as targets for the test. The test involved utilising the WXR MAP mode function and pointing the WXR at these targets and recording the painted terrain returns. The painted terrain returns from the occurrence WXR and RU were then compared.



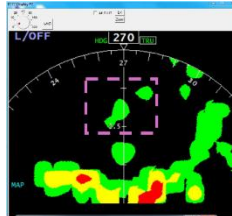
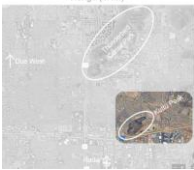
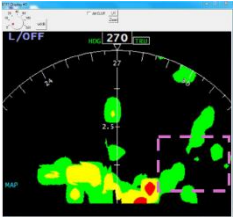
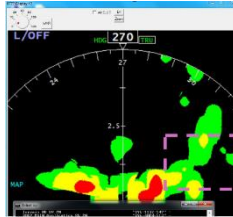
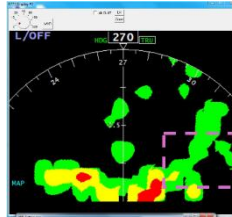



Figure 17: WXR transmission and reception operational test targets

A1.3 The test was carried out in the following system configurations:

System	Components involved			
RU	RU radar antenna	RU DA	One of RU TRs	One of RU RPs
WXR-L	Occurrence radar antenna	Occurrence DA	Occurrence left TR	Occurrence left RP
WXR-R			Occurrence right TR	Occurrence right RP

A1.4 The table below summarises the targets which were picked up or not picked up by the relevant WXR (with “✓” denoting that a target was picked up and “X” denoting that a target was not picked up):

Target	Reference WXR Unit (RU)	Occurrence WXR-L	Occurrence WXR-R
Range setting: 5nm			
Thunderbird Conservation Park 	✓ 	X 	✓ Painted but not entirely similar to RU 
Kuttu Peak 	✓ 	✓ Painted but not entirely similar to RU 	✓ Painted but not entirely similar to RU 
Range setting: 40nm			

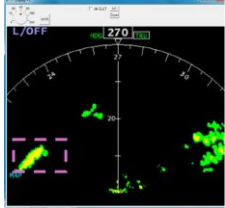
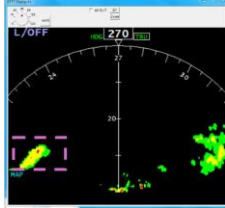
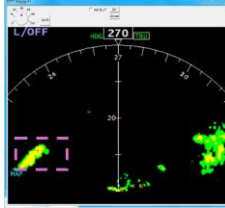
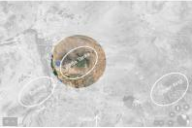
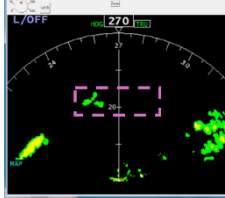
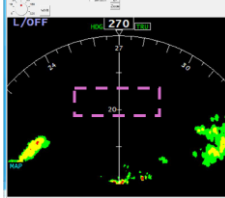
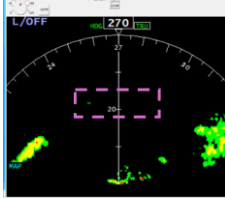
<p>Estrella</p> 	<p>✓ Painted in yellow</p> 	<p>✓ Painted with additional small red area</p> 	<p>✓ Painted with additional small red area</p> 
<p>White Tanks</p> 	<p>✓ Painted in green</p> 	<p>X</p> 	<p>X</p> 

A1.5 In summary, the investigation team noted the following:

- (a) Over-painting by WXR-L and WXR-R in respect of Estrella
- (b) Under-painting by WXR-L in respect of Thunderbird Conservation Park
- (c) No-painting by WXR-L and WXR-R in respect of White Tanks
- (d) WXR-L and WXR-R were over-painting one terrain feature (e.g. Estrella and Kuttu Peak) but under-painting or not painting another (e.g. White Tank and Thunderbird Conservation Park).

A1.6 As regards the indications of over- and under-painting highlighted by the investigation team in paragraph A1.5, the WXR OEM deemed that the discrepancies were within tolerance. For example, in the case of paragraph A1.5(c) where the RU picked up a green return for White Tank and where WXR-L and WXR-R did not (thus the display was showing black), the WXR OEM deemed that the reflectivity difference between green and black could be as little as 1dBz and such a difference was within limits. The WXR OEM deemed that the consistency of the other features painted during the test did not support a characterisation of over- or under-painting. The WXR OEM concluded that the occurrence WXR performed within expected limits, as compared with the reference unit.

A2 Tests using Acceptance Test Procedure (ATP) (hereinafter referred to as ATP tests)

A2.1 The ATP tests were to verify that the occurrence components meet their performance requirements as designed by the component manufacturers.

A2.2 The WXR OEM's test result is as follows:

- (a) The occurrence DA, right TR, right and left RPs passed the first ATP tests.
- (b) The occurrence left TR failed the first ATP test owing to the transmit power output being slightly below the minimum acceptable value, but it passed a re-test.

(See paragraph A4 on additional tests and examination of the DA.)

A2.3 The occurrence CP underwent ATP test by the CP OEM after the ITP test described in paragraph A3. The test result is as follows:

- (a) The left and right gain controls for WXR-L and WXR-R operated normally.
- (b) The right ALT knob on WXR-R exhibited some slight changing of altitude value when wiggling the knob. The CP OEM deemed this acceptable.

The CP OEM concluded that there was no issue with the occurrence CP.

A3 Test using Integration Test Procedure (ITP) (hereinafter referred to as ITP test)

A3.1 The test was to determine the performance of the occurrence CP when connected to the other occurrence WXR and RU components as indicated in the table below.

A3.2 The table below shows the configurations being tested and the test result:

S/N	Configuration	Test result
	Occurrence CP (left system selected) with:	

1	Occurrence DA	Occurrence TRs	Occurrence RPs	<p>The test found that the VAR text was displayed on the co-pilot ND even when the right GAIN knob was in the 12 o'clock position (i.e. CAL position). (Note: Normally, the VAR text will be displayed on the ND when the GAIN knob is not in the CAL position.)</p> <p>Inspection of the RP internal log file showed that the recorded gain value was -7dB at CAL position when it was supposed to be 0dB.</p> <p>The occurrence CP was sent for further test (see paragraph A3.4).</p>
2	Occurrence DA	Occurrence TRs	RU's RPs	The CP passed the ITP.
	Occurrence CP (right system selected) with:			
3	Occurrence DA	Occurrence TRs	Occurrence RPs	The CP passed the ITP.
4	Occurrence DA	Occurrence TRs	RU's RP ^Δ	The CP passed the ITP.

A3.3 Comparing the test configurations in S/N 1 and S/N 2, in view that the CP did not pass the ITP test in S/N 1, the WXR OEM sent the occurrence CP to the CP OEM to carry out an ATP test (see paragraph A2.3).

A3.4 In addition to the ATP test carried out in paragraph A2.3, and in view of the findings during the flight tests (see paragraph A8^Δ), the occurrence CP underwent another round of ITP test, in combination with the occurrence DA, right TR and right RP. The VAR text did not appear when the GAIN knob was in the CAL position and appeared when the GAIN knob was not in the CAL position. The occurrence CP was deemed to pass the ITP test.

^Δ "RTP" has been amended to "RP".

^Δ "A6" amended to "A8".

A3.5 The WXR OEM postulated, after the first ITP test, the ATP test, the flight test (paragraph A6 below) and the second ITP test, that the occurrence CP could have an intermittent issue but could not explain or determine the cause of the issue.

A4 Temperature cycle test

A4.1 The test was to assess if the occurrence DA and TRs met their design criteria when exposed to temperatures ranging from -55°C to +70°C.

A4.2 The test conditions were as follows:

Configuration	Test result
Occurrence DA and right TR in DA slot 1 with the RU's RP	<p>1st attempt</p> <ul style="list-style-type: none"> • 20 minutes after reaching -55°C, DA was observed to be scanning erratically. • There was no signal received. • The text "ANT FAIL" was displayed on the ND. • Test failed. <p>2nd attempt</p> <ul style="list-style-type: none"> • 7 minutes after reaching -55°C, the DA was observed to be scanning erratically. • There was no signal received. • The text "ANT FAIL" was displayed on the ND. • Test failed
Occurrence DA and left TR in DA slot 1 with the RU's RP	<ul style="list-style-type: none"> • DA was observed to be scanning normally through the entire temperature range. • Test passed.
Occurrence DA, right TR in DA slot 2 and right RP	<ul style="list-style-type: none"> • While the temperature was decreasing to -55°C, a fault was observed at -38°C and the DA exhibited unusual tilt behaviour. • The fault cleared when temperature reached -55°C and the DA resumed normal scanning operations • The fault reappeared at -31°C while temperature was increasing back to +25°C. • The fault cleared when temperature reached -18°C and the DA resumed normal scanning operations.

	<ul style="list-style-type: none"> • Intermittent behaviour that the WXR OEM could not explain. • The text “ANT FAIL” was displayed on the ND. • Test failed.
Occurrence DA, right TR in DA slot 1 and right RP	<ul style="list-style-type: none"> • No anomaly observed in the scanning pattern. • Test passed.
Occurrence DA, Left TR in DA slot 2 and right RP	<ul style="list-style-type: none"> • While the temperature was decreasing to -55°C, a fault was observed at -50°C and the DA exhibited unusual tilt behaviour. • The fault cleared when temperature reached -55°C and the DA resumed normal scanning operations • About 45 minutes into the 2-hour cold soak, the unusual tilt behaviour reappeared on the DA without an accompanying fault. • Subsequently the power supply tripped and power supply was then restored but the unusual tilt behaviour persisted without any accompanying fault code. • Intermittent behaviour. No fault message. The WXR OEM determined that the intermittent behaviour was attributed to the inappropriate power supply used in this test. • Test failed.
Occurrence DA, left TR in DA slot 1 and occurrence left RP and breakout box ⁵⁷ installed	<ul style="list-style-type: none"> • While the temperature was decreasing to -55°C, a fault was observed at -50°C and the DA exhibited unusual tilt behaviour. • The fault cleared 4 minutes later and the DA resumed normal scanning operations • Intermittent behaviour that the WXR OEM could not explain. • The text “ANT FAIL” was displayed on the ND. • Test Failed.

A4.3 Further tests were carried out using the estimated temperature range inside the radome which the occurrence components were exposed to during the occurrence flight (i.e. -7°C to 25°C).

⁵⁷ The breakout box allowed some interval voltages of the TRs to be monitored during the temperature cycle test.

Occurrence DA, right TR in DA slot 2 and occurrence right RP	<ul style="list-style-type: none"> Ambient temperature between -7°C to 25°C (actual flight time and ambient temperature profile derived from flight data recorder data). No anomaly observed in the scanning pattern Test passed.
Occurrence DA, right TR in DA slot 2 and occurrence right RP	<ul style="list-style-type: none"> Ambient temperature between -7°C to 25°C (actual flight time and ambient temperature profile derived from flight data recorder data). The thermal cycle test was left running at -7°C for 8 hours. No anomaly observed in the scanning pattern. Test passed.

A4.4 The DA exhibited unusual performance characteristics in the scanning pattern (i.e. pan and tilt) when the temperature was in the cold temperature range. The irregular scanning pattern was accompanied by a fault and reverted to normal when the temperature subsequently increased. Although the DA did not meet the design criteria, the WXR OEM opined that the unusual scanning did not happen during the occurrence flight as there were no fault codes relating to unusual scanning of the DA.

A5 Highly Accelerated Stress Screen (HASS) test

A5.1 The WXR OEM had previously identified issues of WXR under-painting caused by defective TR diodes. The HASS test was to determine if the TR of the occurrence aircraft had an issue with TR diodes. The test was conducted at the premises of the TR OEM.

A5.2 The TR OEM then carried out a series of Spurious Free Dynamic Range and Minimum Discernible Signal Test on the occurrence left and right TRs in a HASS chamber in the following four temperature conditions:

- (a) HASS chamber set at ambient temperature of +25°C
- (b) HASS chamber temperature lowered to -55°C and the TRs cold soaked for 30 minutes
- (c) HASS chamber temperature raised to +70°C and the TRs soaked for 30 minutes
- (d) HASS chamber temperature reset at ambient temperature of +25°C

A5.3 The test found no issue with the occurrence TRs. The test on the occurrence right TR, which was in use at the time of the occurrence, showed that the radio frequency response was normal. The occurrence WXR-R TR diode passed the test.

A6 Visual inspection of TR-R printed circuit board and diodes

A6.1 Notwithstanding the results of the HASS test, the TR-R was disassembled to inspect the three diodes identified in the Service Information Letter that could have caused the TRs to appear to be operating normally but underpaint the actual weather.

A6.2 The diodes were visually inspected under a high-resolution microscope. It was observed that (see Figure 18 below):

- (a) the solder joints on the diodes' leads were intact and appeared undamaged.
- (b) there were some fine linear scratches on the leads of the diodes.

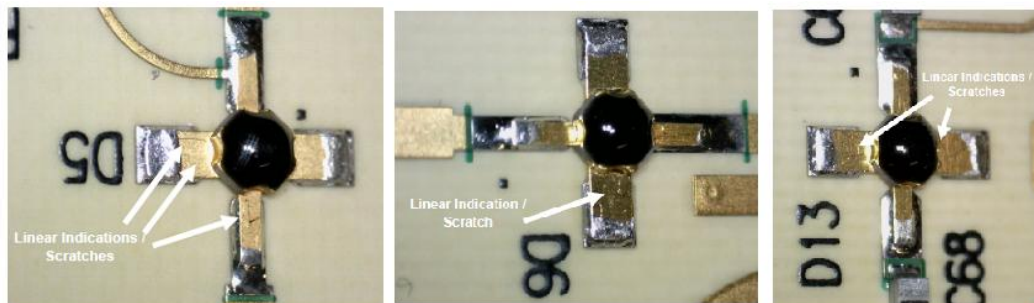

(Source and annotation: WXR OEM)

Figure 18: Visual inspection of TR-R diodes

A6.3 The observations did not affect the performance of TR and there was no issue or defect identified with the diodes.

A7 DA RF Test

A7.1 The occurrence DA underwent a Voltage Standing Wave Ratio (VSWR)⁵⁸ and Insertion Loss⁵⁹ Test to evaluate the RF paths between the TRs and the antenna. The test conducted showed insertion loss within limits (1.3dB and 1.16dB against a 2dB maximum) and the VSWR values were slightly outside typical figures but were observed to be stable. The results were consistent with in-service equipment, not indicative of underperformance and assessed to have negligible impact on system performance. The test did not reveal any issue with the DA's RF path that would contribute to weather under-painting.

A8 Flight Test

A8.1 The occurrence components were fitted on a test aircraft (B757) for in-flight checks. On the test aircraft, only one WXR system could be installed. Thus, the WXR-L and WXR-R components were tested on two different days. The flight path, altitude and weather conditions on both days were similar.

A8.2 Normally, the VAR text would only be displayed on the ND when the GAIN knob was not at the 12 o'clock (i.e. the CAL) position. Results of the flight test with occurrence WXR-L (occurrence radar antenna, CP, DA, left TR and left RP) and occurrence WXR-R (occurrence radar antenna, CP, DA, right TR and right RP) were as follows:

- (a) When the GAIN knobs were set to the CAL position for both WXR-L and WXR-R, the right ND⁶⁰ appeared to be under-painting as compared with the left ND (**Figure 19**), and the VAR text⁶¹ was displayed (red arrow showing VAR text on the right ND).

⁵⁸ VSWR measures the efficiency of the power transmission from source (i.e. TR) to load (i.e. antenna).

⁵⁹ Insertion Loss measures the reduction in signal power when a device is introduced into a transmission line.

⁶⁰ The VAR text was displayed in green on the top right corner of the ND on the B757 test aircraft. On a B777, the test will be displayed in cyan on the bottom left corner of the ND.

⁶¹ During the occurrence flight and the ferry flight from Bangkok to Singapore after the occurrence, the flight crews did not report any VAR text being displayed.



(Source: WXR OEM) (Annotation: TSIB)
 (GAIN knobs not from actual aircraft. For illustration purposes only)

Figure 19: Comparison of left and right NDs when GAIN knobs were set to CAL position (red arrow showing VAR text on the right ND)

- (b) When the right GAIN knob was turned to the 2 o'clock position (corresponding to an increase in gain), the weather returns on both the NDs appeared similar and the VAR text, which should appear on the right ND at this GAIN knob position, did not appear (see **Figure 20**).

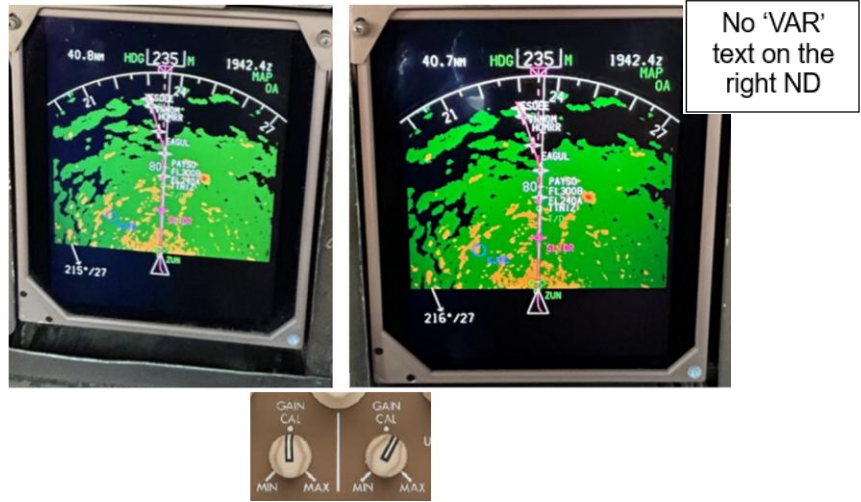

(Source: WXR OEM)
 (GAIN knobs not from actual aircraft. For illustration purposes only)

Figure 20: Comparison of left and right NDs when left GAIN knob was set to CAL position and right GAIN knob set at 2 o'clock position

A8.3 During the flight test, there was a discussion that the CP GAIN knob could be outputting an incorrect gain value, such that the ND would indicate the VAR text even when the GAIN knob was in the CAL position. However, the CP passed a second ITP test after the flight test (see paragraph A3.4) without undergoing any rectification or adjustments. The WXR OEM determined that there could be an intermittent fault with the CP.

A9 Additional tests and examination of occurrence DA

A9.1 The WXR OEM had previously come across DAs that had defective ribbon cables. The test was to validate a hypothesis that scanning anomalies observed at or below -35°C in the temperature chamber tests in the WXR OEM facility were due to worn ribbon cables. A system test and an examination of the DA were carried out.

A9.2 A system test was carried out on the occurrence DA with two different configurations to monitor the ribbon cable for opened or shorted-to-chassis circuits.

- (a) Configuration 1 – Side 1 of the DA was connected to the calibration test bench and a DA system test cable device was connected to Side 2 of the DA. The following was observed:
 - (i) The ground-chassis continuity light (LED DS13) illuminated red at certain antenna positions⁶², indicating that the ribbon cable was shorted to the DA chassis.
 - (ii) The remaining 12 ground-chassis continuity lights (LED DS1-DS12) illuminated green throughout the test, indicating that none of the ground lines were shorted to the DA chassis.
- (b) Configuration 2 – The test was repeated with Side 2 of the DA connected to the calibration test bench and a DA system test cable device connected to Side 1 of the DA. The result was the same as for configuration 1.

⁶²The red LED illuminated only when the antenna sweep reached its right-side end limit (viewed from the left side of the aircraft as installed). It was not illuminated at any other point during the antenna sweep.

A10 Examination of occurrence DA

- A10.1 There are two ribbon cables (blue in colour), Ribbon 1 and Ribbon 2, in a DA that receive signals from the TRs to control the scanning pattern of the antenna. Ribbon 1 is associated with Side 1 of the DA and the left TR and left RP. Ribbon 2 is associated with Side 2 of the DA and the right TR and right RP.
- A10.2 The occurrence DA was disassembled to inspect Ribbon 1 and Ribbon 2. The inspection revealed scoring and debris. No exposed conductor was found on Ribbon 2, whereas about four inches (102mm) of exposed conductor was found on Ribbon 1 (see **Figure 21**).



(Source: WXR OEM)

Figure 21: Conductor found exposed on Ribbon 1

- A10.3 In light of the potential shorting of ground lines described in paragraph A9.2(a), additional testing was conducted on both ribbon cables. This included end-to-end resistance measurements on each conductor to verify continuity, as well as resistance checks between adjacent conductor to detect any cross-wire shorts. Both ribbon cables showed good end-to-end conductivity for all conductors and no cross-wire shorts.
- A10.4 The WXR OEM's assessment was as follows:
- (a) The scoring and debris found on the ribbon cables represent normal wear, which would not affect performance of the occurrence DA.
 - (b) The conductor exposed on Ribbon 1 is a ground line. Although its contact with the chassis would be sufficient to trigger illumination of the red ground-chassis continuity LED on the cable test bench, this is not expected to result in excess current draw or other abnormal

behaviours of the radar system. Ribbon 1 did not contribute to any potential no painting or under-painting of the weather during the occurrent flight, given that it was not active during the occurrence flight.

- (c) Ribbon 2 had no exposed conductors or cross-wire shorts, however it still triggered the illumination of the red ground-chassis continuity LED on the cable test bench. The cause of this LED illumination was not determined. According to the WXR OEM, although Ribbon 2 was active during the accident flight, and no exposed conductor was found, the Ribbon 2 cable was not expected to have contributed to any potential no-painting or under-painting of weather returns during the occurrence flight.