

Uplifting Lift Standards for Safety and Maintainability - *Design Compliance to SS550: 2020 Requirements*

Desmond Ang

Senior Engineer

Building and Construction Authority

Electrical and Mechanical Engineering Group

Investigation & Enforcement Department



Agenda

- Recap on adoption of SS550:2020 for regulatory regime
- Highlights of code requirements
 - Type Testing of safety components
 - Lift related building design
 - Car size compliance
 - Suspension means

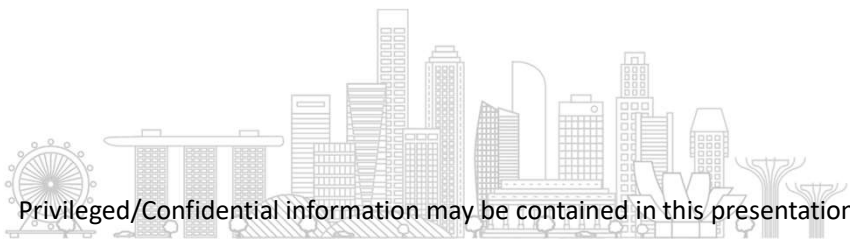

Privileged/Confidential information may be contained in this presentation. Please do not circulate or reproduce without the permission of BCA.

Adoption of SS550:2020

- SS550:2020 was launched on 8th Jan 2021.
- Circular was issued by BCA in Jan 2021:
-> Any lifts in project with 1st set of plans submitted on or after 1st July 2021 will need to comply to SS550:2020.

11 January 2021

See Distribution List

Dear Sir/Madam

ADOPTION OF SS 550:2020 (CODE OF PRACTICE FOR INSTALLATION, OPERATION AND MAINTENANCE OF ELECTRIC PASSENGER AND GOODS LIFTS) AS ACCEPTABLE SOLUTION FOR COMPLIANCE WITH FIFTH SCHEDULE OF THE BUILDING CONTROL REGULATIONS

Objective

The purpose of this circular is to inform the industry on the adoption of SS 550:2020 as the acceptable solution for compliance with the requirements for the design and installation of lifts under Fifth Schedule of the Building Control Regulations.

EFFECTIVE DATE FOR IMPLEMENTATION OF SS 550:2020 – CODE OF PRACTICE FOR INSTALLATION, OPERATION AND MAINTENANCE OF ELECTRIC PASSENGER AND GOODS LIFTS

2 The SS 550:2020 - Code of Practice for Installation, Operation and Maintenance of Electric Passenger and Goods Lifts was launched on 8 January 2021 at the Webinar: SS 550:2020 Code of Practice for Installation, Operation and Maintenance of Electric Passenger and Goods Lifts, organised by Enterprise Singapore. At the Webinar, BCA also announced that it would adopt the revised SS as the acceptable solution for compliance with the design and installation requirements for lifts under the Fifth Schedule of the Building Control Regulations.

3 This circular informs the industry of the adoption of SS 550:2020, with a six-month grace period for the industry to transit from the existing SS 550:2009 (Amendment 2 & 3, 2017) to SS 550:2020.

4 A key requirement in the SS 550:2020 is the type examination of the safety components (see **Annex A**) specified in the SS in accordance with EN81-50. It should be noted that, for the purpose of complying with the Fifth Schedule of the Building Control Regulations – the type examination must be performed by a Certification Body



Type Testing Requirements

Type-testing of Critical Components

Specific safety components must obtain type-testing certification in accordance with **EN81-50** Standards.

Lift Components to be Type-tested

- Car/Landing Door Locking Device
- Safety Gear
- Overspeed Governor
- Buffers

(to be continued in next slide)



Type Testing Requirements

Type-testing of Critical Components

Specific safety components must obtain type-testing certification in accordance with **EN81-50** Standards.

(Continued)

- Safety Circuits containing Programmable Electronics Systems in Safety Related Applications for Lifts (PESSRAL) or Electronic Components
- Ascending Car Overspeed Protection Means (ACOP)
- Unintended Car Movement Protection Means (UCMP)
- Rupture Valve/One Way Restrictor (for Hydraulic Lifts)



Type Testing Requirements

Regulatory Requirements for Type Testing

- The Type Testing certificates have to be included as an annex to CSC04 during applications for TOP/CSC and 1st PTO.
- More details (e.g. available certification bodies for each component) can be found in the circular in the link below:

<https://www1.bca.gov.sg/docs/default-source/docs-corp-news-and-publications/circulars/circular-on-adoption-of-ss-550-2020.pdf>



Lift Related Building Design

Motor room

Motor rooms shall be provided with:

- **ventilation** so as to ensure that the temperature measured at any point within 1,0 m of the machinery and associated equipment **shall not exceed 38 °C**. **Mechanical ventilation** is recommended where the **ambient temperature** is expected to **exceed 32 °C**. – this is to reduce the risk of machinery overheating and to provide worker comfort
- **permanently installed electric lighting** with an intensity of **at least 200 lux at floor level everywhere a person needs to work** and 50 lux at floor level to move between working areas – to ensure proper visibility is provided for lift workers
- **proper access** (continued in next 2 slides) and is **accessible by authorized personnel**.



Lift Related Building Design

Proper access to machinery spaces/motor room – This is essential to ensure that lift service personnel are able to safely access the machine room for rescue or repair works (with the necessary replacement parts or equipment) at all time.

Requirements for access route to the machinery spaces:

- Provided with a sheltered passage way of at least a clear width of 1m and a clear height of 2.0m
- Must not be slippery & safety railing shall be provided along passage way if it is less than 1.5m away from edge of roof
- Provided with staircase if there is difference in level between floor and final machinery access



Lift Related Building Design

Proper access to machinery spaces/motor room

Requirements for access route to the machinery spaces:

- In the exceptional case when a conventional staircase cannot be provided, proper fixed ladders can be used (for height within 4m).
- Some ladder design requirements (full list given in 5.2.2.5 of code):
 - For ladder access over 3m in height, fall protection shall be provided;
 - Ladders exceeding 1.5m in height shall (when in position of access) form an angle of 65 to 75 deg to the horizontal (ship ladder) and not liable to slip or turn over.

Access doors to machinery spaces/machine room shall have a minimum clear opening height of 2m and width of 1m.



Lift Related Building Design

Lift Shaft Ventilation

Lift wells shall be adequately ventilated at the top of the shaft to the external air by means of **one or more permanent openings** having an unobstructed area of **at least 1% of the horizontal section of the well and not less than 0.1 m²** for each lift in the shaft.

Example of ventilation louvre in lift shaft

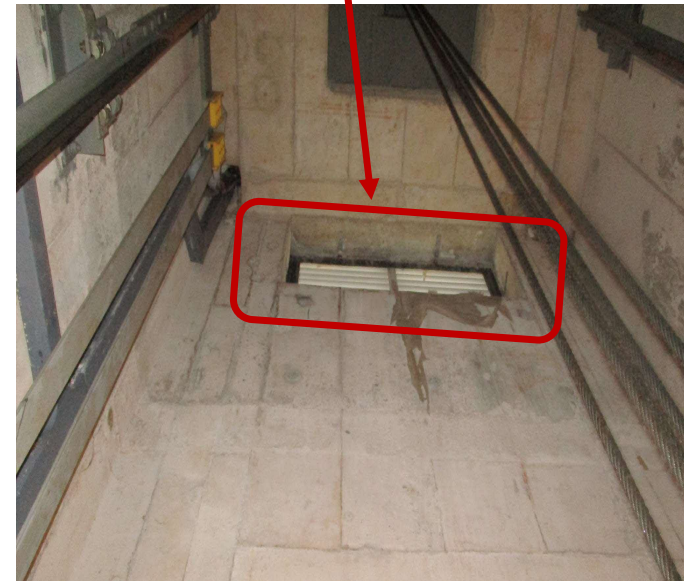

Lift Related Building Design

Access to pit

A means to enter the pit shall be provided consisting of:

- a) an access door where the pit depth exceeds 2.50 m;
- b) either an access door or a ladder inside the well, easily accessible from the landing door, where the pit depth is not exceeding 2.50 m.

Access doors to pit shall have a min. clear opening height of 2m and width of 1m.

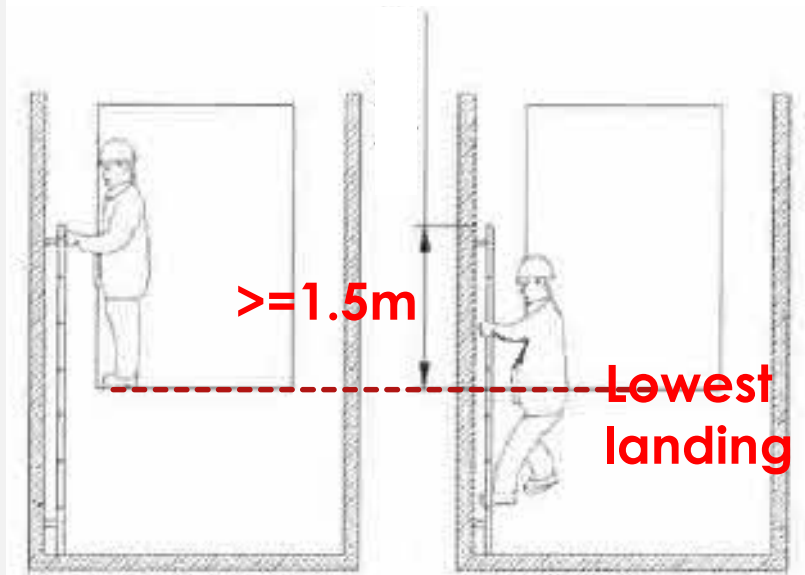

Type 1 - Fixed pit ladder

Image source: SS550:2020



Lift Related Building Design

Adjacent lift pits

Where the well contains several lifts there shall be a partition between the moving parts of different lifts.

This partition shall extend from within 0.30 m from the pit floor to a height of 2.50 m above the floor of the lowest landing.

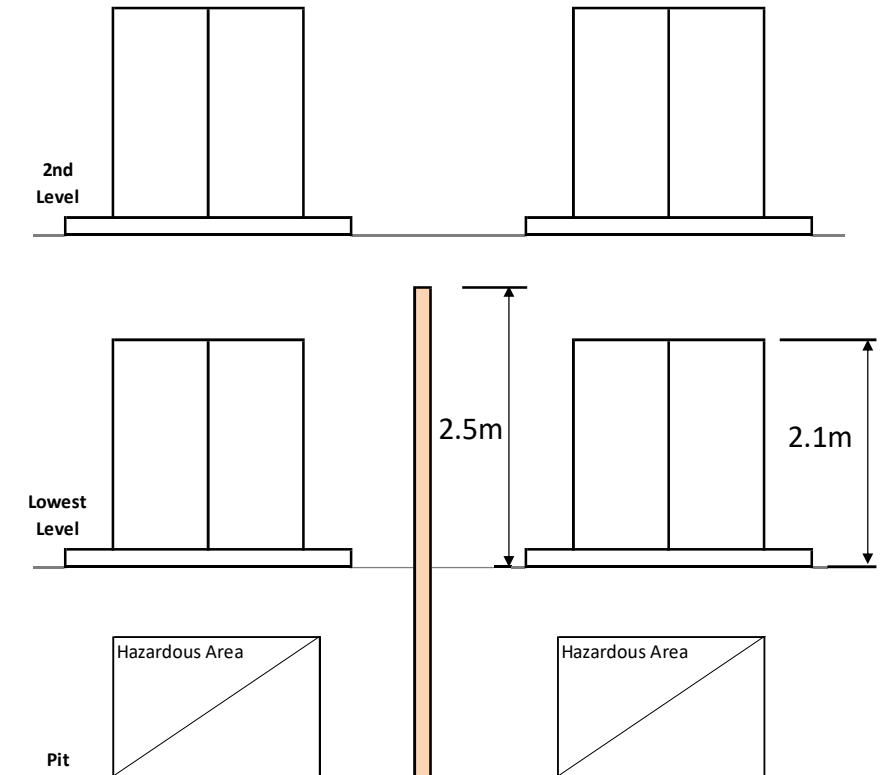

Lift Related Building Design

Car Bottom Clearances

When the car is at its lowest position:

- **Minimum 2 refuge space**, which must be marked out clearly
- Lowest pt from car bottom to pit floor to be \geq **500mm**.



Type	Posture	Pictogram	Horizontal dimensions of the refuge space (m x m)	Height of the refuge space (m)
1	Upright		0,40 x 0,50	2,00
2	Crouching		0,50 x 0,70	1,00
3	Laying		0,70 x 1,00	0,50

Image source: SS550:2020



Lift Related Building Design

Car Top Clearances

- At highest position, minimum 2 refuge spaces which must be marked out clearly

Table 3 – Dimensions of refuge spaces in headroom

Type	Posture	Pictogram	Horizontal dimensions of the refuge space (m x m)	Height of the refuge space (m)
1	Upright		0,40 x 0,50	2,00
2	Crouching		0,50 x 0,70	1,00

Image source:
SS550:2020



Lift Related Building Design

Car Top Clearances (continued)

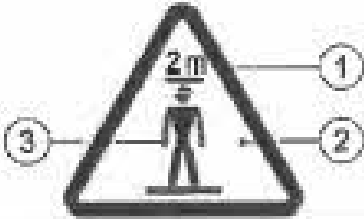
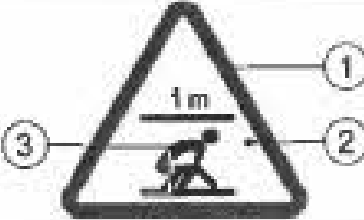
- Balustrade to be minimally 1.1m in height and shall not be $\geq 150\text{mm}$ from the edge of car roof
- At highest position, lowest pt of ceiling shall not protrude below the height of the balustrade (or 1.1m if no balustrade)

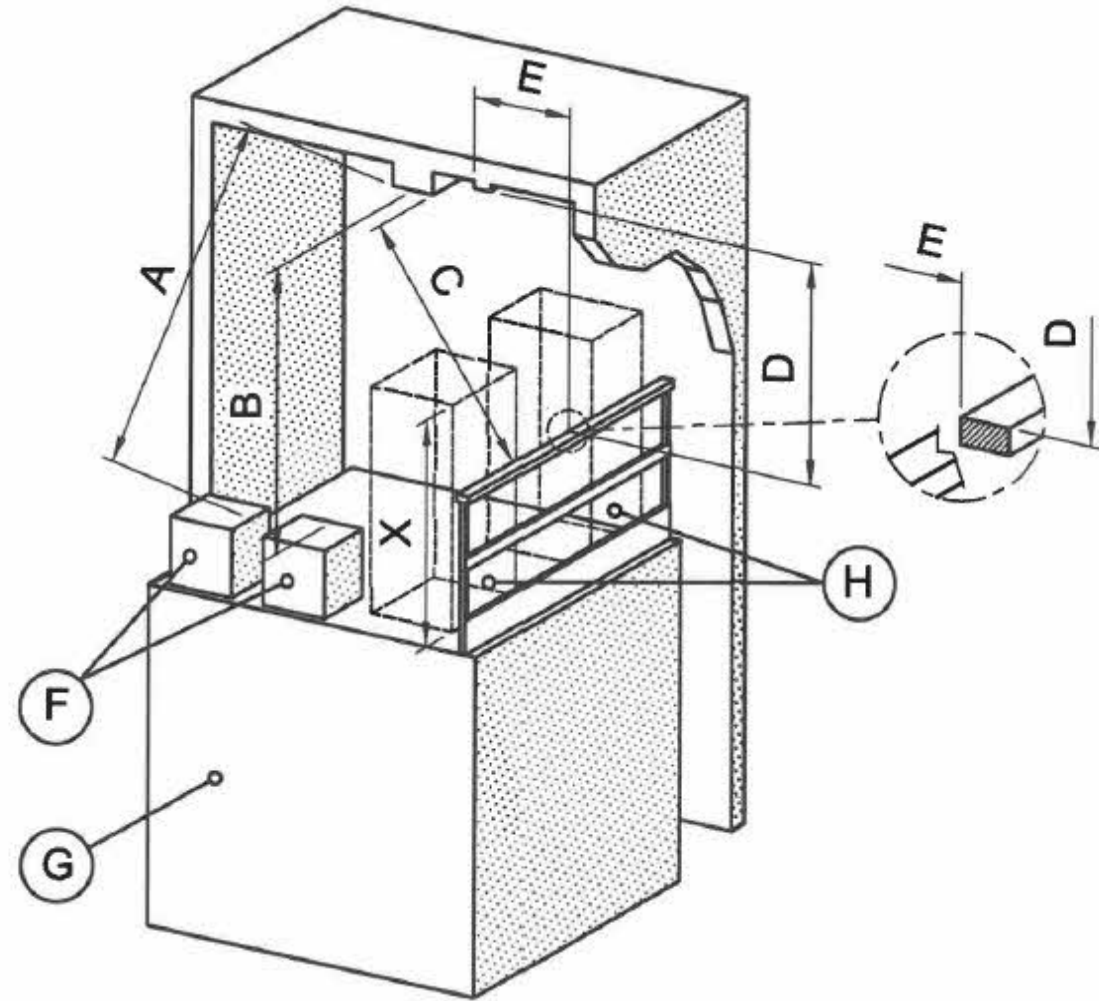

Image source: SS550:2020



Lift Related Building Design

Permanent access to lift well for private lift

If access to the lift for maintenance and rescue purposes is via private premises, then permanent access of authorized persons to the premises and relevant instructions shall be provided.

As a minimum, permanent maintenance access must be provided at the topmost, lowest landings and preferably also at one or more intermediate landings.

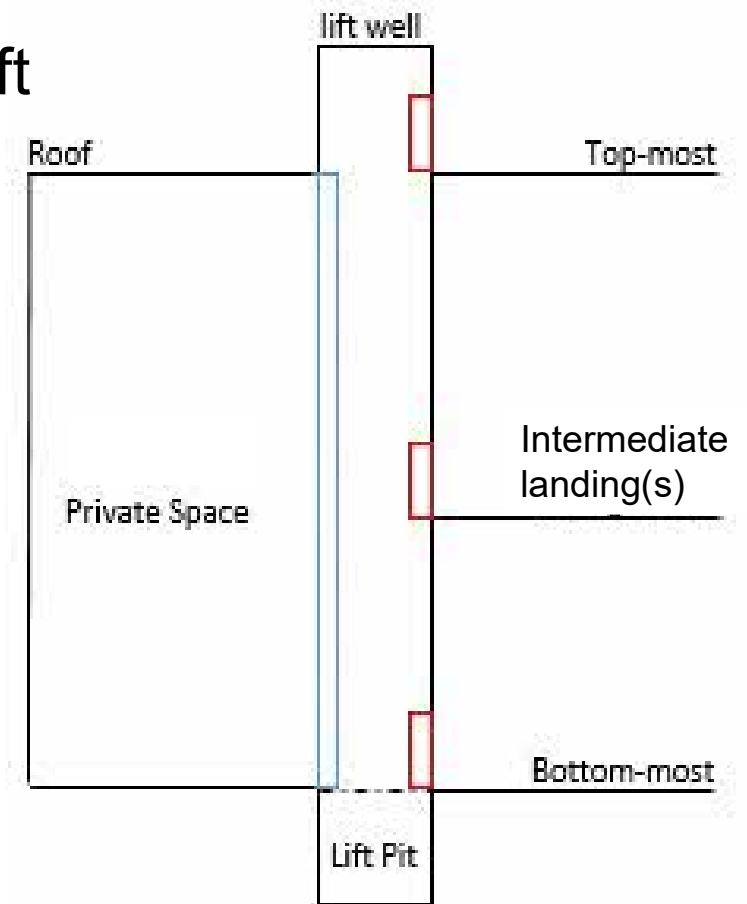

Image source: SS550:2020



Car Size Compliance

Table 6 – Rated load and maximum available car area

Rated load, mass (kg)	Maximum available car area (m ²)	Rated load, mass (kg)	Maximum available car area (m ²)
100 ^a	0,37	900	2,20
180 ^b	0,58	975	2,35
225	0,70	1000	2,40
300	0,90	1050	2,50
375	1,10	1125	2,65
400	1,17	1200	2,80
450	1,30	1250	2,90
525	1,45	1275	2,95
600	1,60	1350	3,10
630	1,66	1425	3,25
675	1,75	1500	3,40
750	1,90	1600	3,56
800	2,00	2000	4,20
825	2,05	2500 ^c	5,00

a) Minimum for 1 person lift.

b) Minimum for 2 persons lift.

c) Beyond 2500 kg add 0,16 m² for each extra 100 kg.

For intermediate loads the area is determined by linear interpolation.

Table 7 – Rated load and maximum available car area (for goods lifts)

Rated load, mass (kg)	Maximum available car area (m ²)	Rated load, mass (kg)	Maximum available car area (m ²)
400	1,68	975	3,52
450	1,84	1000	3,60
525	2,08	1050	3,72
600	2,32	1125	3,90
630	2,42	1200	4,08
675	2,56	1250	4,20
750	2,80	1275	4,26
800	2,96	1350	4,44
825	3,04	1425	4,62
900	3,28	1500	4,80
		1600 ^{a)}	5,04

a) Beyond 1600 kg, add 0,40 m² for each 100 kg extra.

For intermediate loads, the area is determined by linear interpolation.

Max. available Car area vs rated load shall be compliant to Tables 6 and 7 as shown.

Image source: SS550:2020



Key Requirements for Belt Lift Systems

Key Requirements

Suspension belts shall be made of **composite materials with steel** as one of the **core material** and **have properties not inferior** to that of steel wire ropes

Minimum number of belts shall be **3**

Suspension belts shall be **independent**

The ratio between the pitch diameter of sheaves and the nominal diameter of embedded steel cord of the belts shall be **at least 40**

Safety factor of the belts shall not be **less than 12**

Junction between the belt and the belt termination shall resist at **least 80%** of minimum breaking load of the belt

Continuous Belt Monitoring System



Continuous Belt Monitoring System

5.5.1.1 Note 3: Where the steel element in such composite material is not visible, monitoring for its deterioration to be provided to prevent unexpected failure

Continuous Belt Monitoring System

- shall be **installed** in belt lift
- must **continuously** monitor **condition** of the **steel cords** within the PU coating via **direct measurements** (e.g. electrical resistance/inductance) of the **cord's physical parameters** (*Note that belt slack switch and trip counter are not considered as a continuous monitoring solution*)
- shall **stop the lift operations** in the event of:
 - **Deterioration** in any of the embedded steel cords
 - **Loss of residual strength**
 - **Belt breakage**

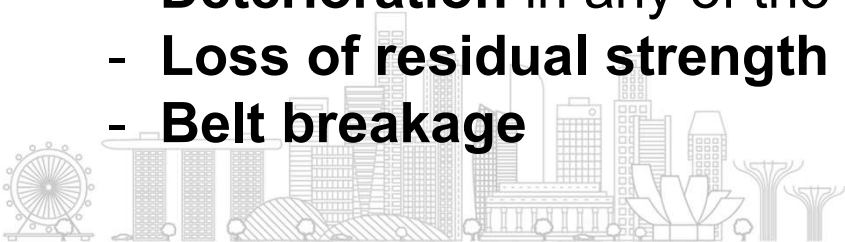

Thank you



@BCASingapore

